



Specifications of basic booths (System panels booth)

- Specifications of basic booths (P1)
- Top View of Basic Booth (P1)
- Specifications of basic booth components (P2)
- Notes (P2)

Packaged Booth Information

- Schedule (P3)
- Packaged Booth Display • 1 booth (P4, P5)
- Packaged Booth Display • 2 booths (P6, P7)
- Packaged Booth Display • 3 booths (P8, P9)

Optional Tools (P10- P13)

Color Sample (P14)

Order Form

- Packaged Booth Display Order Form (P15)
- Optional Tool Order Form (P16)

For further information and request on "System Panel" and "Package Booth",
please contact the following company.

Ten Co.,LTD.

Morimitu Shinkou Bldg.9F, 5-9, Kotobuki, 1-chome, Taitou-ku, Tokyo 111-0042, JAPAN

Fax : +81-3-3842-7720

E-mail : jasis@teninc.co.jp

★ I apologize for bothering you, but please contact us by E-mail.

Specifications of basic booths (System panels booth)

The specifications of system panels which we use for basic booths are as follows.

● Specifications of basic booths

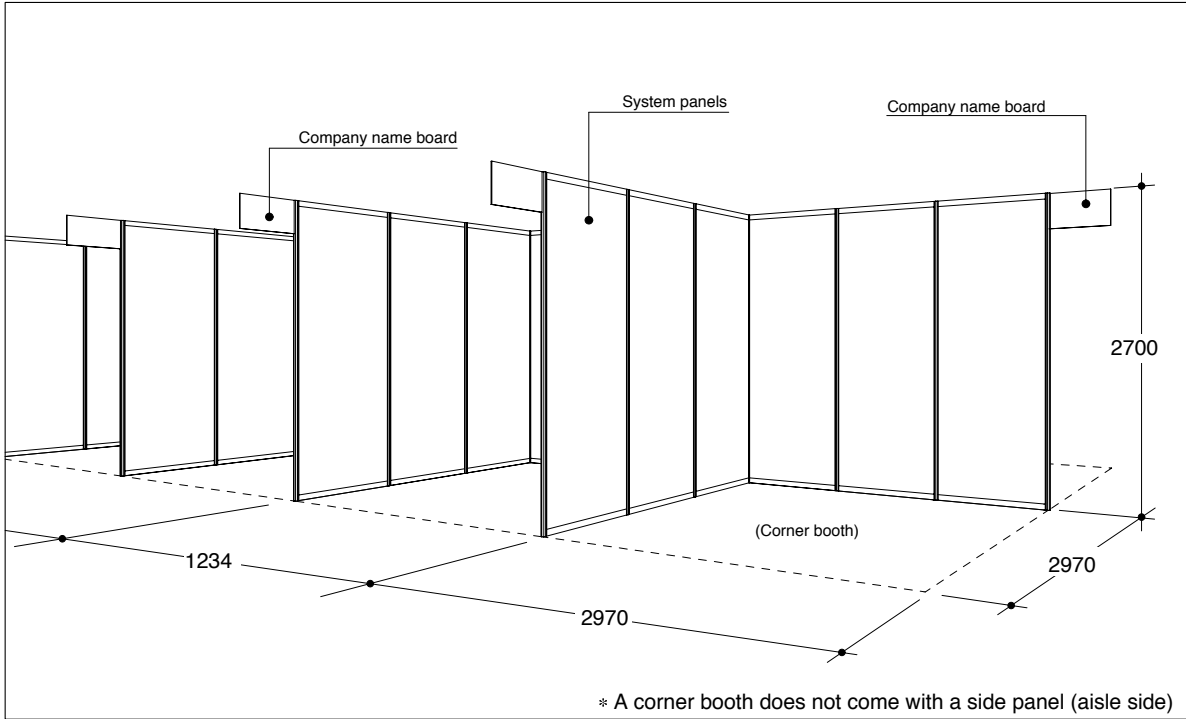

● Top View of Basic Booth

*Measurements are from a center to a center of pillars.
*Unit : millimeters

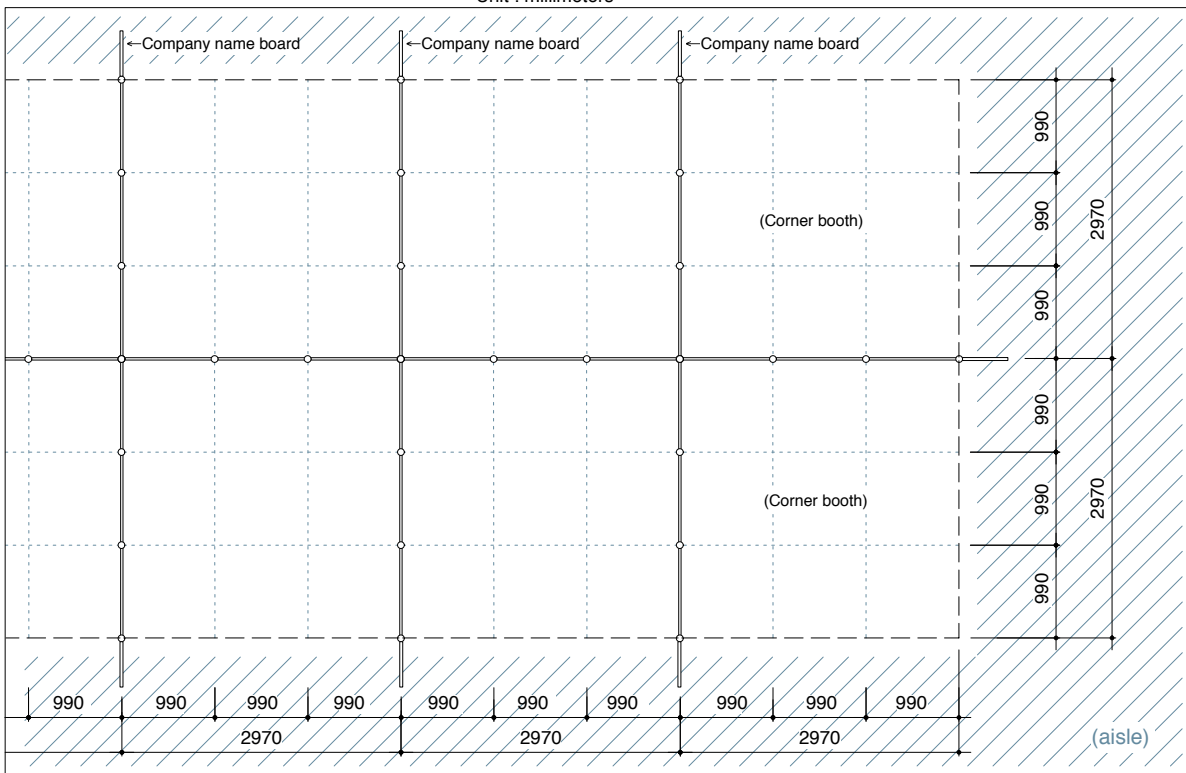

● Specifications of basic booth components

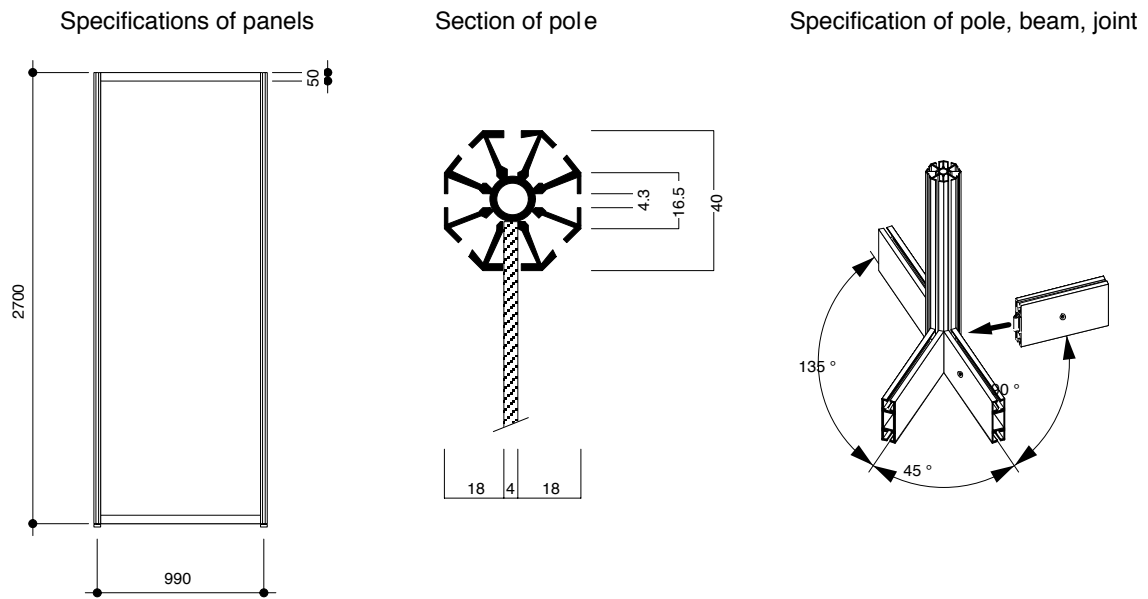

● Notes

- 1 System panels are composed of vinyl-coated plywood with white color.
- 2 Panels can be mounted with S-shaped hooks with chain and /or a Velcro tape.
- 3 System panels cannot be directly decorated or processed.
 - Nailing, cutting or making holes on the booth components (panel boards, beams, etc.) is strictly prohibited.
 - Neither pins nor a strong double-sided adhesive tape can be used.

Packaged Booth Information

- ◆ All indicated prices and fees exclude applicable tax and entry fee.
- ◆ Unless specified, all listed prices and fees are subject to 10% consumption tax.
- ◆ Exhibitors willing to order one of the packaged booth plans (p.4-p.9) or optional tool(s) which requires electricity supply are requested to submit “Electrical work wiring diagram” in JASIS “Exhibit Service Manual (the manual)” as well as the order form(s) on p.15 & p.16 in this booklet. The manual is planned to be available in June on JASIS website.
- ◆ JASIS office issue electrical wiring to trunk line and electricity usage invoice after JASIS to exhibitors who ordered packaged booth plan or selected optional tool(s) which requires electricity supply. Please refer to the manual for detailed electric fees information.
 Note: Electrical wiring inside your booth such as placing outlets will be separately billed by designated booth contractor.
- ◆ Exhibitors using cabinet, a key for exclusive use is available upon request. Fee is JPY 700/each.

● Schedule

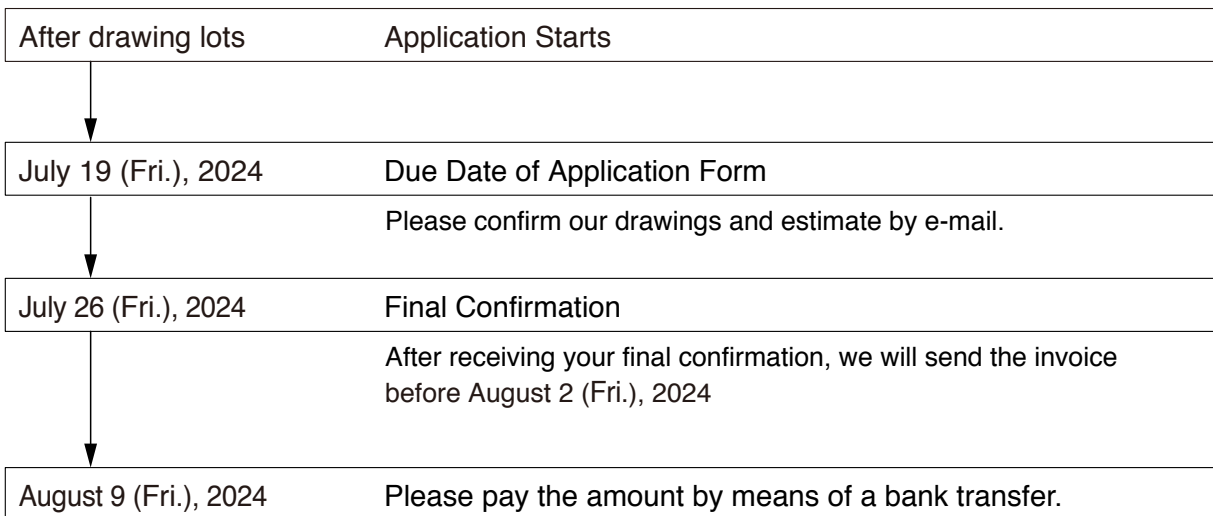

(The order for the construction of the booth will be placed when the full payment of the invoice has been made. We retain the right to reject the order if you fail to pay the invoice in full by the due date. Notwithstanding the above, we may accept such order at our option even if the full payment is delayed. In case of the acceptance of the order, the work schedule may be changed, if necessary, by discussion between the parties.)

For further information and request on “System Panel” and “Package Booth”, please contact the following company.

Ten Co.,LTD.

Morimitu Shinkou Bldg.9F, 5-9, Kotobuki, 1-chome, Taitou-ku, Tokyo 111-0042, JAPAN

Fax : +81-3-3842-7720

E-mail : jasis@teninc.co.jp

★ I apologize for bothering you, but please contact us by E-mail.

● Packaged Booth Display • 1 booth

Packaged Booth Display 1-A

Total JPY45,400 (10% tax and entry fee excluded)

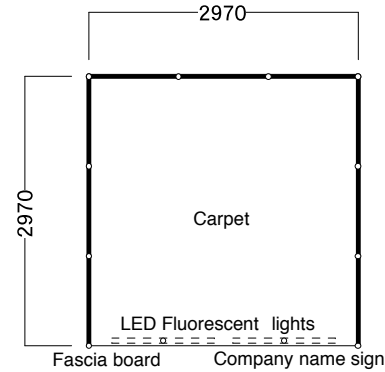
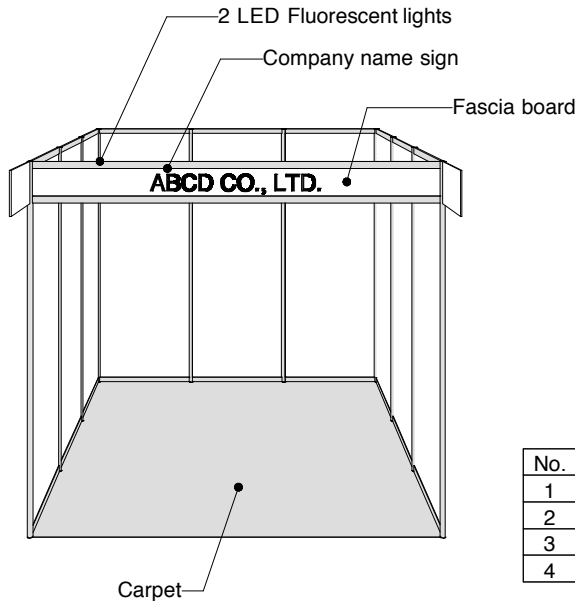

No.	Item	Notes	Q'ty
1	Fascia board		1
2	Company name sign	Font / Gothic Corner, Color / Black	1
3	LED Fluorescent lights	21W	2
4	Carpet	* Please refer to the color sample.	1

* A corner booth comes with a header instead of side panel (aisle side).

* All indicated prices exclude tax and entry fee. By ordering a packaged booth plan, you also obligate to submit "Electrical work wiring diagram form" in JASIS "Exhibit Service Manual" which is available on JASIS website in June; associated electrical wiring and usage fees are invoiced post JASIS.

Packaged Booth Display 1-B

Total JPY87,880 (10% tax and entry fee excluded)

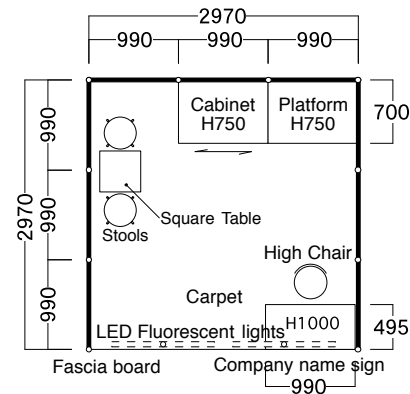
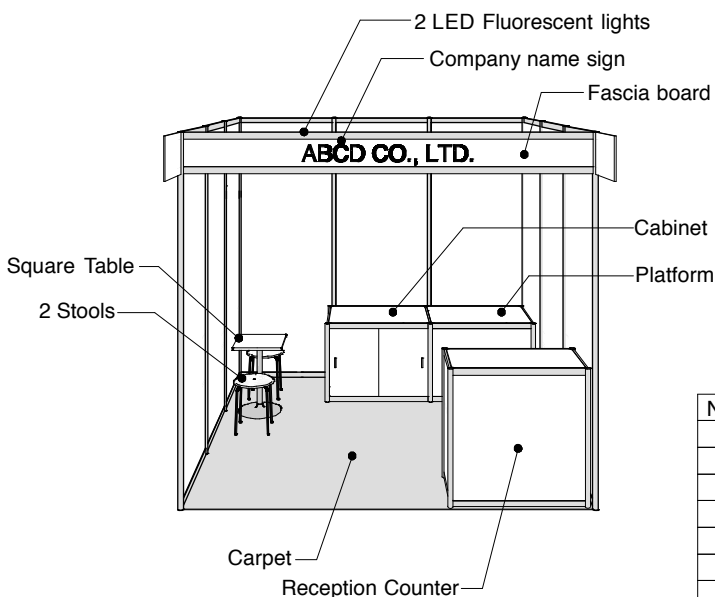

No.	Item	Notes	Q'ty
1	Fascia board		1
2	Company name sign	Font / Gothic Corner, Color / Black	1
3	LED Fluorescent lights	21W	2
4	Carpet	* Please refer to the color sample.	1
5	Platform	990*700*H750	1
6	Cabinet	990*700*H750	1
7	Reception Counter	990*495*H1000/ Ledged	1
8	High Chair		1
9	Square Table	450*450*H650	1
10	Stool		2

* A corner booth comes with a header instead of side panel (aisle side).

* The exclusive key for your cabinet is available at exhibitors' request.
JPY700/ea

* All indicated prices exclude tax and entry fee. By ordering a packaged booth plan, you also obligate to submit "Electrical work wiring diagram form" in JASIS "Exhibit Service Manual" which is available on JASIS website in June; associated electrical wiring and usage fees are invoiced post JASIS.

===== Please contact us for protective equipment for COVID-19 and other infectious diseases =====

● Packaged Booth Display • 1 booth

Packaged Booth Display 1-C

Total JPY81,200 (10% tax and entry fee excluded)

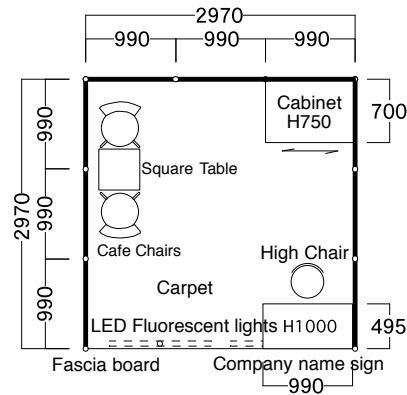
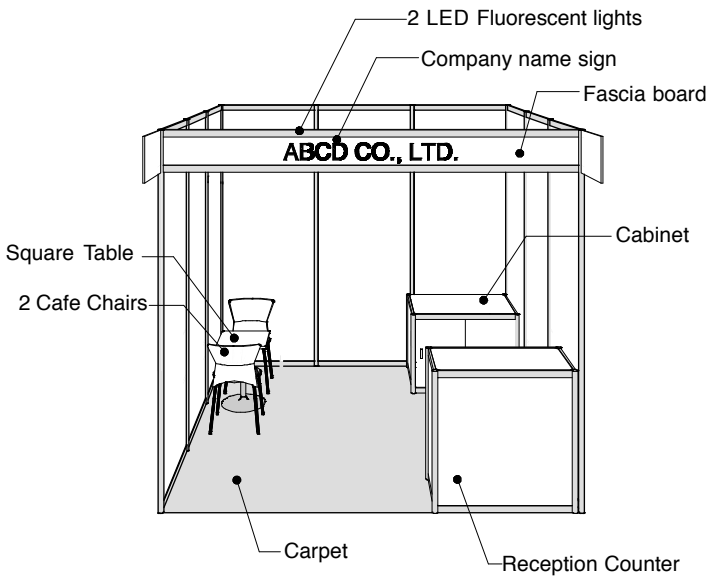

No.	Item	Notes	Q'ty
1	Fascia board		1
2	Company name sign	Font / Gothic Corner, Color / Black	1
3	LED Fluorescent lights	21W	2
4	Carpet	* Please refer to the color sample.	1
5	Cabinet	990*700*H750	1
6	Reception Counter	990*495*H1000/ Ledged	1
7	High Chair		1
8	Square Table	450*450*H650	1
9	Cafe Chair		2

※ A corner booth comes with a header instead of side panel (aisle side).
 ※ The exclusive key for your cabinet is available at exhibitors' request.
 JPY700/ea

* All indicated prices exclude tax and entry fee. By ordering a packaged booth plan, you also obligate to submit "Electrical work wiring diagram form" in JASIS "Exhibit Service Manual" which is available on JASIS website in JUNE; associated electrical wiring and usage fees are invoiced post JASIS.

Packaged Booth Display 1-D

Total JPY95,600 (10% tax and entry fee excluded)

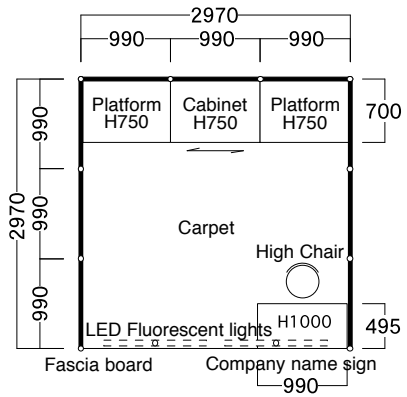
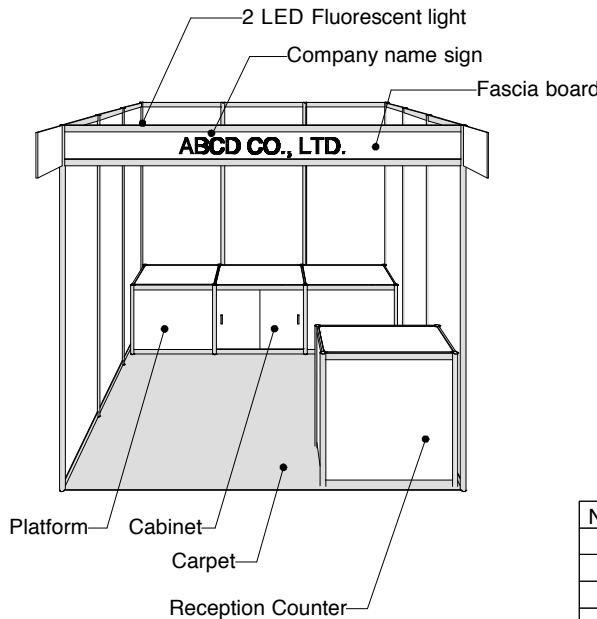

No.	Item	Notes	Q'ty
1	Fascia board		1
2	Company name sign	Font / Gothic Corner, Color / Black	1
3	LED Fluorescent lights	21W	2
4	Carpet	* Please refer to the color sample.	1
5	Platform	990*700*H750	2
6	Cabinet	990*700*H750	1
7	Reception Counter	990*495*H1000/ Ledged	1
8	High Chair		1

※ A corner booth comes with a header instead of side panel (aisle side).
 ※ The exclusive key for your cabinet is available at exhibitors' request.
 JPY700/ea

* All indicated prices exclude tax and entry fee. By ordering a packaged booth plan, you also obligate to submit "Electrical work wiring diagram form" in JASIS "Exhibit Service Manual" which is available on JASIS website in JUNE; associated electrical wiring and usage fees are invoiced post JASIS.

===== Please contact us for protective equipment for COVID-19 and other infectious diseases =====

● Packaged Booth Display · 2 booths

Packaged Booth Display 2-A

Total JPY90,800 (10% tax and entry fee excluded)

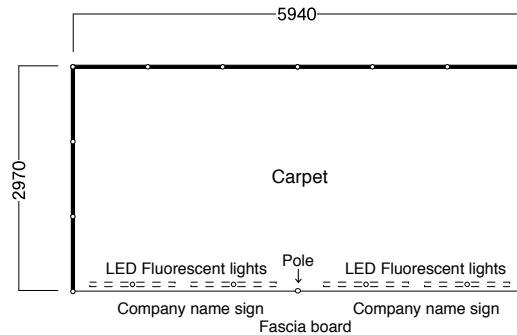
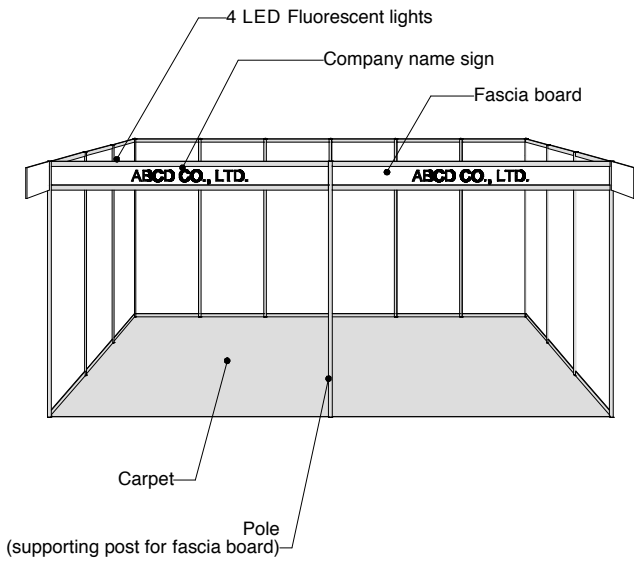

No.	Item	Notes	Q'ty
1	Fascia board		1
2	Pole	supporting post for fascia board	1
3	Company name sign	Font / Gothic Corner, Color / Black	2
4	LED Fluorescent lights	21W	4
5	Carpet	* Please refer to the color sample.	2

* A corner booth comes with a header instead of side panel (aisle side).

* All indicated prices exclude tax and entry fee. By ordering a packaged booth plan, you also obligate to submit "Electrical work wiring diagram form" in JASIS "Exhibit Service Manual" which is available on JASIS website in June; associated electrical wiring and usage fees are invoiced post JASIS.

Packaged Booth Display 2-B

Total JPY177,600 (10% tax and entry fee excluded)

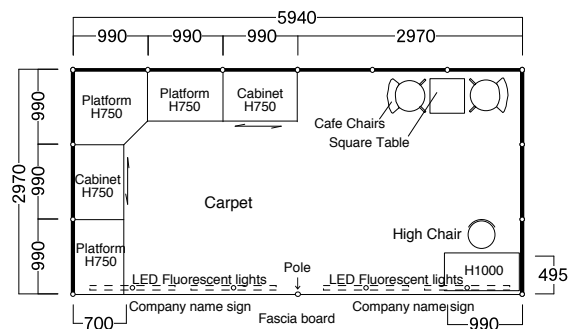
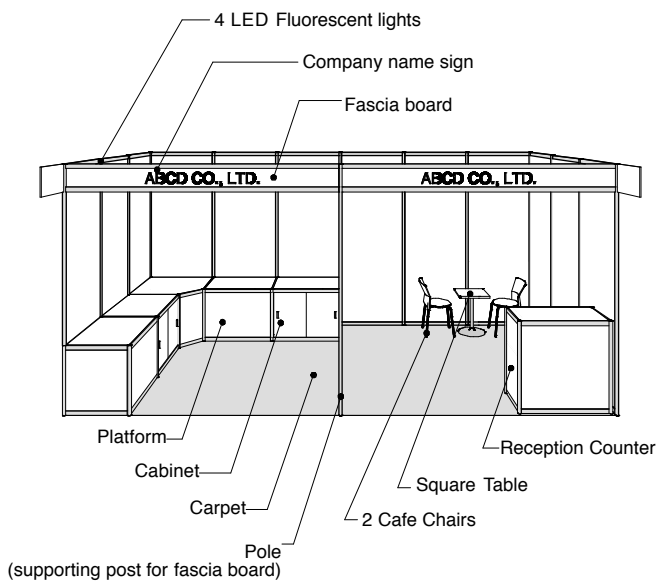

No.	Item	Notes	Q'ty
1	Fascia board		1
2	Pole	supporting post for fascia board	1
3	Company name sign	Font / Gothic Corner, Color / Black	2
4	LED Fluorescent lights	21W	4
5	Carpet	* Please refer to the color sample.	2
6	Platform	990*700*H750/2, 990*990*H750/1	3
7	Cabinet	990*700*H750	2
8	Reception Counter	990*495*H1000/ Ledged	1
9	High Chair		1
10	Square Table	450*450*H650	1
11	Cafe Chair		2

* A corner booth comes with a header instead of side panel (aisle side).

* The exclusive key for your cabinet is available at exhibitors' request.

JPY700/ea

* All indicated prices exclude tax and entry fee. By ordering a packaged booth plan, you also obligate to submit "Electrical work wiring diagram form" in JASIS "Exhibit Service Manual" which is available on JASIS website in June; associated electrical wiring and usage fees are invoiced post JASIS.

==== Please contact us for protective equipment for COVID-19 and other infectious diseases =====

● Packaged Booth Display • 2 booths

Packaged Booth Display 2-C

Total JPY201,300 (10% tax and entry fee excluded)

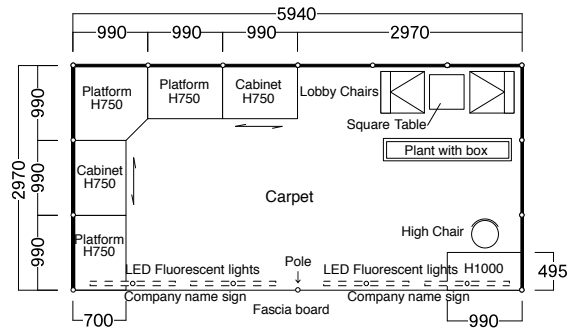
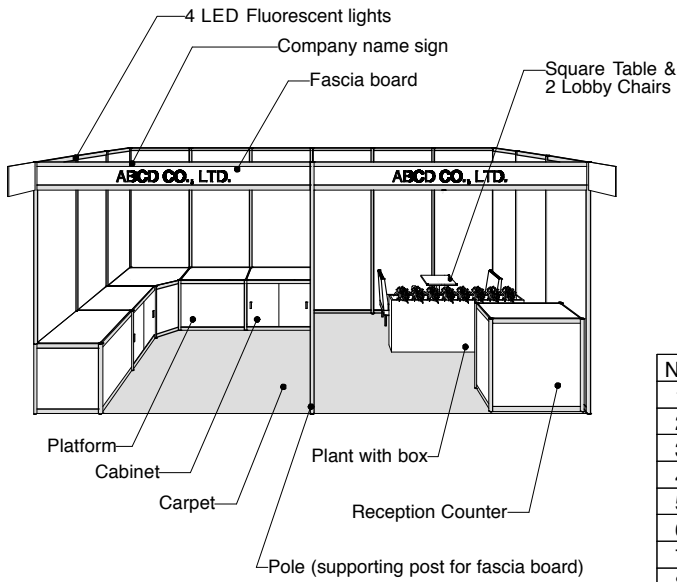

No.	Item	Notes	Q'ty
1	Fascia board		1
2	Pole	supporting post for fascia board	1
3	Company name sign	Font / Gothic Corner, Color / Black	2
4	LED Fluorescent lights	21W	4
5	Carpet	* Please refer to the color sample.	2
6	Platform	990*700*H750/2, 990*990*H750/1	3
7	Cabinet	990*700*H750	2
8	Reception Counter	990*495*H1000/ Ledge	1
9	High Chair		1
10	Square Table	450*450*H650	1
11	Lobby Chair		2
12	Plant with box	W1800	1

- * A corner booth comes with a header instead of side panel (aisle side).
 - * The exclusive key for your cabinet is available at exhibitors' request.
- JPY700/ea

* All indicated prices exclude tax and entry fee. By ordering a packaged booth plan, you also obligate to submit "Electrical work wiring diagram form" in JASIS "Exhibit Service Manual" which is available on JASIS website in June; associated electrical wiring and usage fees are invoiced post JASIS.

Packaged Booth Display 2-D

Total JPY209,580 (10% tax and entry fee excluded)

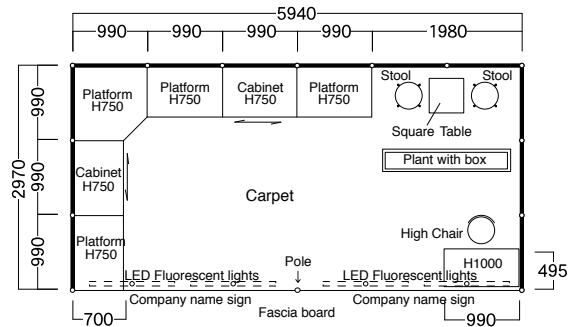
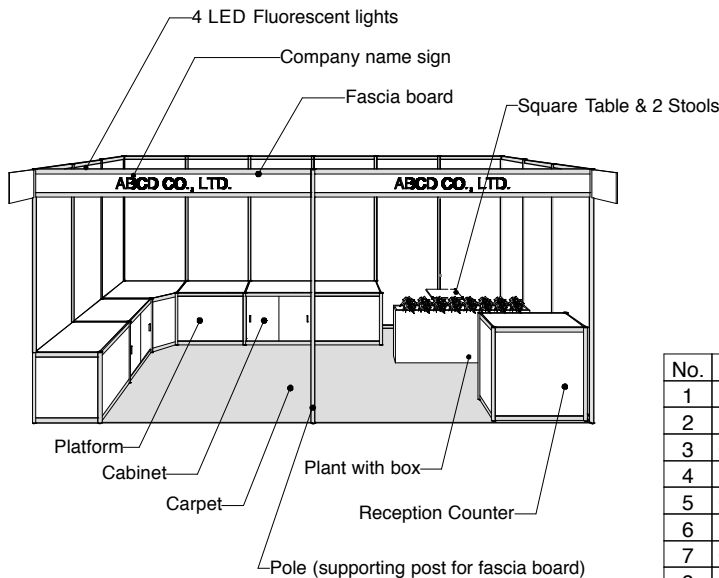

No.	Item	Notes	Q'ty
1	Fascia board		1
2	Pole	supporting post for fascia board	1
3	Company name sign	Font / Gothic Corner, Color / Black	2
4	LED Fluorescent lights	21W	4
5	Carpet	* Please refer to the color sample.	2
6	Platform	990*700*H750/3, 990*990*H750/1	4
7	Cabinet	990*700*H750	2
8	Reception Counter	990*495*H1000/ Ledge	1
9	High Chair		1
10	Square Table	450*450*H650	1
11	Stool		2
12	Plant with box	W1800	1

- * A corner booth comes with a header instead of side panel (aisle side).
 - * The exclusive key for your cabinet is available at exhibitors' request.
- JPY700/ea

* All indicated prices exclude tax and entry fee. By ordering a packaged booth plan, you also obligate to submit "Electrical work wiring diagram form" in JASIS "Exhibit Service Manual" which is available on JASIS website in June; associated electrical wiring and usage fees are invoiced post JASIS.

==== Please contact us for protective equipment for COVID-19 and other infectious diseases =====

● Packaged Booth Display • 3 booths

Packaged Booth Display 3-A

Total JPY136,200 (10% tax and entry fee excluded)

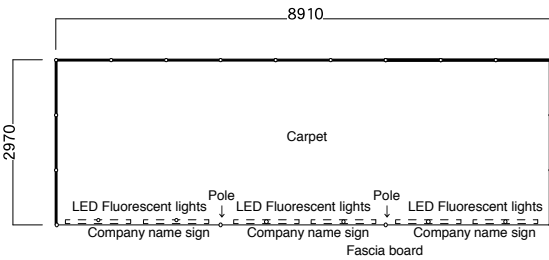
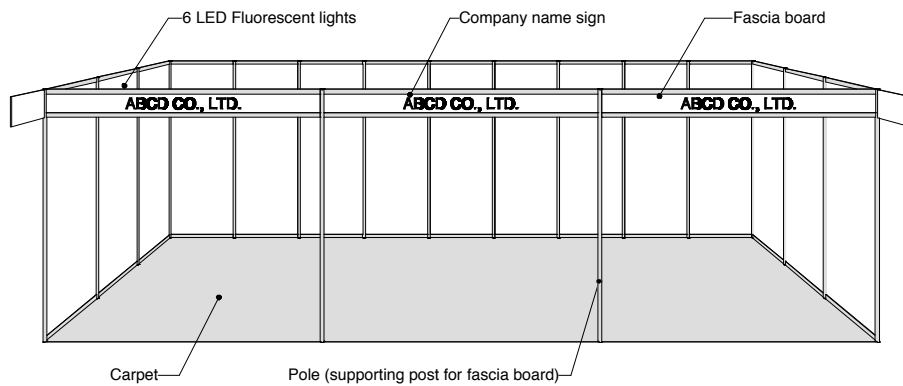

No.	Item	Notes	Q'ty
1	Fascia board		1
2	Pole	supporting post for fascia board	2
3	Company name sign	Font / Gothic Corner, Color / Black	3
4	LED Fluorescent lights	21W	6
5	Carpet	* Please refer to the color sample.	3

* A corner booth comes with a header instead of side panel (aisle side).

* All indicated prices exclude tax and entry fee. By ordering a packaged booth plan, you also obligate to submit "Electrical work wiring diagram form" in JASIS "Exhibit Service Manual" which is available on JASIS website in June; associated electrical wiring and usage fees are invoiced post JASIS.

Packaged Booth Display 3-B

Total JPY282,500 (10% tax and entry fee excluded)

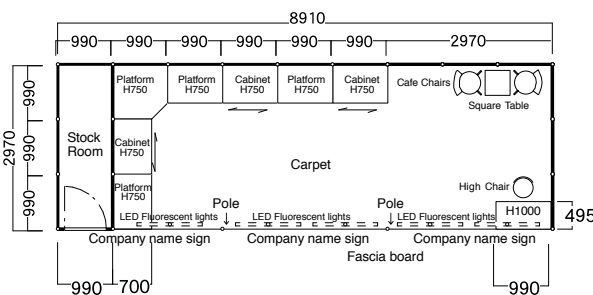
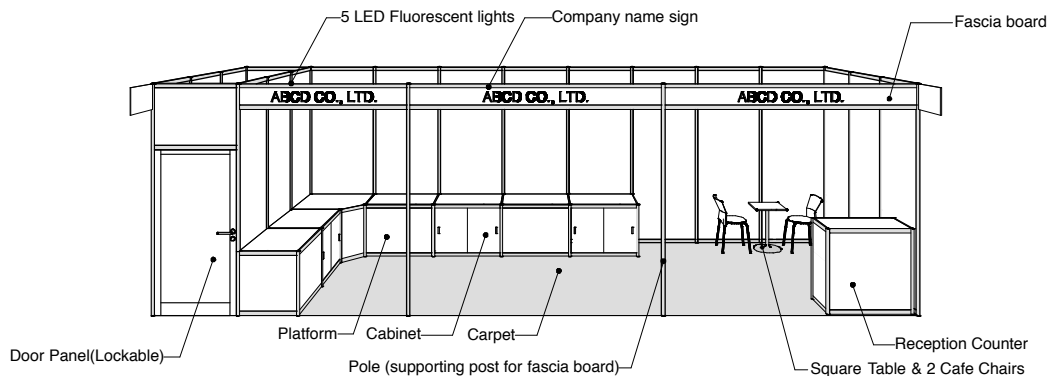

No.	Item	Notes	Q'ty
1	Fascia board		1
2	Pole	supporting post for fascia board	2
3	Company name sign	Font / Gothic Corner, Color / Black	3
4	LED Fluorescent lights	21W	5
5	Carpet	* Please refer to the color sample.	3
6	W990 Panel	H2700/Wall of Stock Room	3
7	Door Panel	W990*H2700 / Lockable	1
8	Platform	990*700*H750/3, 990*990*H750/1	4
9	Cabinet	990*700*H750	3
10	Reception Counter	990*495*H1000/ Ledged	1
11	High Chair		1
12	Square Table	450*450*H650	1
13	Cafe Chair		2

* A corner booth comes with a header instead of side panel (aisle side).

* The exclusive key for your cabinet is available at exhibitors' request.
JPY700/ea

* All indicated prices exclude tax and entry fee. By ordering a packaged booth plan, you also obligate to submit "Electrical work wiring diagram form" in JASIS "Exhibit Service Manual" which is available on JASIS website in June; associated electrical wiring and usage fees are invoiced post JASIS.

==== Please contact us for protective equipment for COVID-19 and other infectious diseases =====

● Packaged Booth Display • 3 booths

Packaged Booth Display 3-C **Total JPY299,040** (10% tax and entry fee excluded)

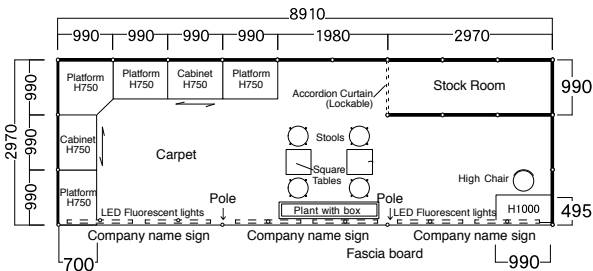
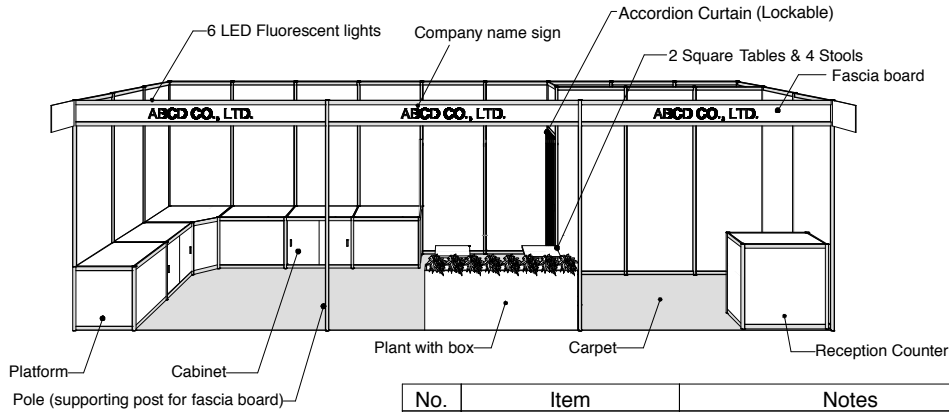

No.	Item	Notes	Q'ty
1	Fascia board		1
2	Pole	supporting post for fascia board	2
3	Company name sign	Font / Gothic Corner, Color / Black	3
4	LED Fluorescent lights	21W	6
5	Carpet	* Please refer to the color sample.	3
6	W990 Panel	H2700/Wall of Stock Room	3
7	Accordion Curtain	W990*H2700 / Lockable	1
8	Platform	990*700*H750/3, 990*990*H750/1	4
9	Cabinet	990*700*H750	2
10	Reception Counter	990*495*H1000/ Ledged	1
11	High Chair		1
12	Square Table	450*450*H650	2
13	Stool		4
14	Plant with box	W1800	1

* A corner booth comes with a header instead of side panel (aisle side).
 * The exclusive key for your cabinet is available at exhibitors' request.
 JPY700/ea

* All indicated prices exclude tax and entry fee. By ordering a packaged booth plan, you also obligate to submit "Electrical work wiring diagram form" in JASIS "Exhibit Service Manual" which is available on JASIS website in June; associated electrical wiring and usage fees are invoiced post JASIS.

Packaged Booth Display 3-D **Total JPY306,200** (10% tax and entry fee excluded)

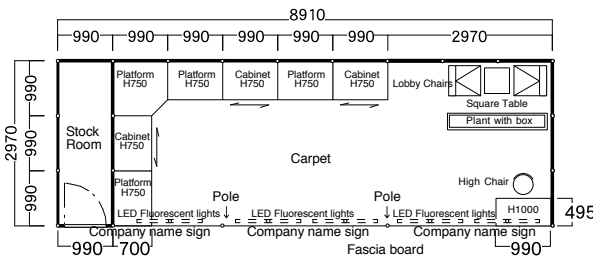
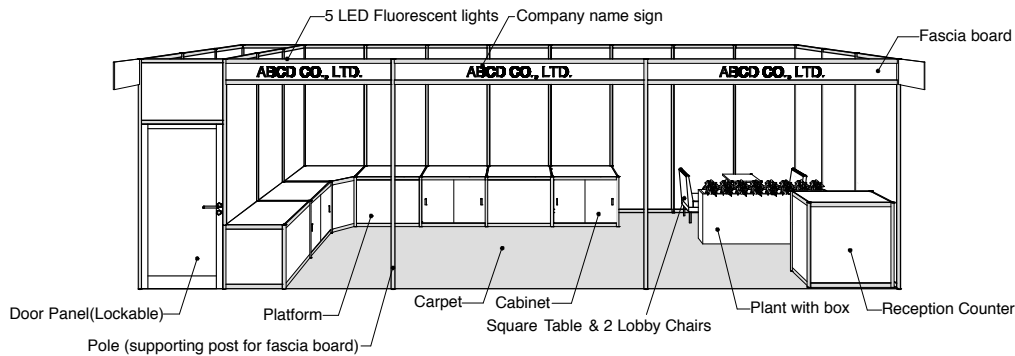

No.	Item	Notes	Q'ty
1	Fascia board		1
2	Pole	supporting post for fascia board	2
3	Company name sign	Font / Gothic Corner, Color / Black	3
4	LED Fluorescent lights	21W	5
5	Carpet	* Please refer to the color sample.	3
6	W990 Panel	H2700/Wall of Stock Room	3
7	Door Panel	W990*H2700 / Lockable	1
8	Platform	990*700*H750/3, 990*990*H750/1	4
9	Cabinet	990*700*H750	3
10	Reception Counter	990*495*H1000/ Ledged	1
11	High Chair		1
12	Square Table	450*450*H650	1
13	Lobby Chair		2
14	Plant with box	W1800	1

* A corner booth comes with a header instead of side panel (aisle side).
 * The exclusive key for your cabinet is available at exhibitors' request.
 JPY700/ea

* All indicated prices exclude tax and entry fee. By ordering a packaged booth plan, you also obligate to submit "Electrical work wiring diagram form" in JASIS "Exhibit Service Manual" which is available on JASIS website in June; associated electrical wiring and usage fees are invoiced post JASIS.

===== Please contact us for protective equipment for COVID-19 and other infectious diseases =====

● Optional Tool ●

Option Tool 1-16

System parts

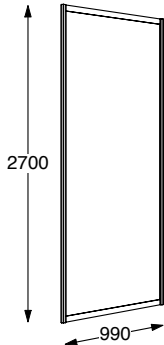
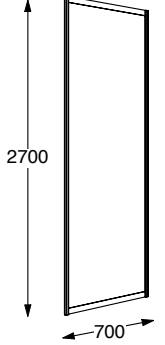
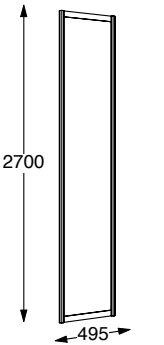
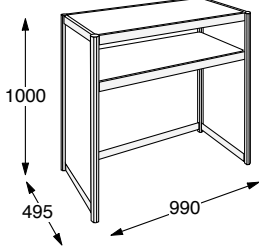
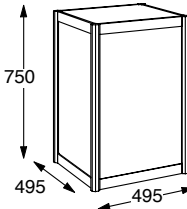
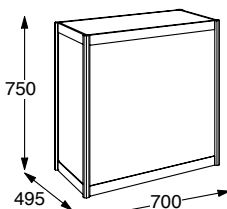
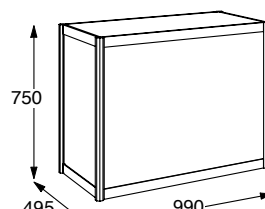
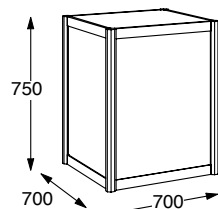
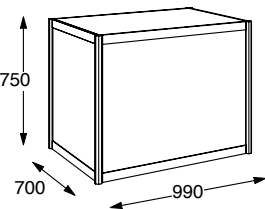
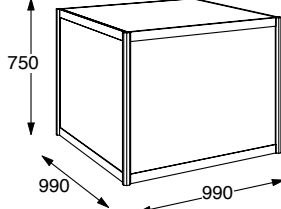
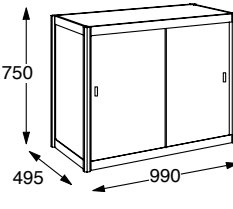
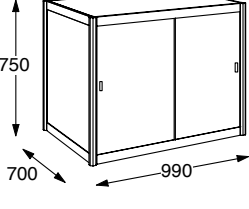
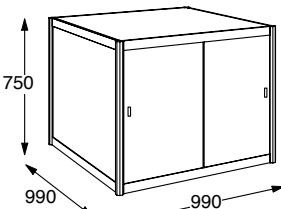
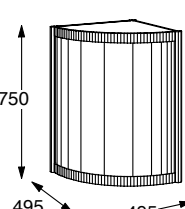
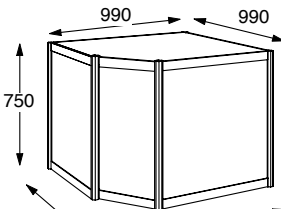
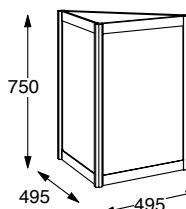
 <p>2700 990</p>	 <p>2700 700</p>	 <p>2700 495</p>	 <p>1000 495 990</p> <p>W990×D495×H1000</p>
<p>1 Wall Panel (W990) JPY6,500</p>	<p>2 Wall Panel (W700) JPY5,500</p>	<p>3 Wall Panel (W495) JPY5,500</p>	<p>4 Reception Counter JPY12,000</p>
<p>Withstand Load: 60kg</p>  <p>750 495 495</p> <p>W495×D495×H750</p>	<p>Withstand Load: 60kg</p>  <p>750 495 700</p> <p>W700×D495×H750</p>	<p>Withstand Load: 60kg</p>  <p>750 495 990</p> <p>W990×D495×H750</p>	<p>Withstand Load: 60kg</p>  <p>750 700 700</p> <p>W700×D700×H750</p>
<p>5 Display Platform JPY6,000</p>	<p>6 Display Platform JPY7,000</p>	<p>7 Display Platform JPY8,000</p>	<p>8 Display Platform JPY9,000</p>
<p>Withstand Load: 60kg</p>  <p>750 700 990</p> <p>W990×D700×H750</p>	<p>Withstand Load: 60kg</p>  <p>750 990 990</p> <p>W990×D990×H750</p>	<p>Withstand Load: 60kg</p>  <p>750 495 990</p> <p>W990×D495×H750</p>	<p>Withstand Load: 60kg</p>  <p>750 700 990</p> <p>W990×D700×H750</p>
<p>9 Display Platform JPY11,000</p>	<p>10 Display Platform JPY14,000</p>	<p>11 Cabinet JPY10,000</p>	<p>12 Cabinet JPY13,000</p>
<p>Withstand Load: 60kg</p>  <p>750 990 990</p> <p>W990×D990×H750</p>	<p>Withstand Load: 60kg</p>  <p>750 495 495</p> <p>W495×D495×H750</p>	<p>Withstand Load: 60kg</p>  <p>990 990 750 700 700</p> <p>W990×D990×H750</p>	<p>Withstand Load: 60kg</p>  <p>750 495 495</p> <p>W495×D495×H750</p>
<p>13 Cabinet JPY16,000</p>	<p>14 495R Display Platform JPY8,000</p>	<p>15 Corner Display Platform JPY16,000</p>	<p>16 495L Display Platform JPY6,000</p>

* The exclusive key for your cabinet is available at exhibitors' request. JPY700/ea

● Optional Tool ●









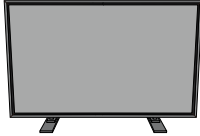

Option Tool 17-32

System parts / Rental

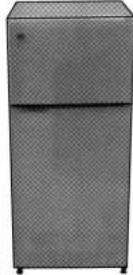
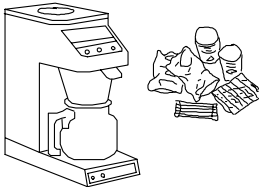
 <p>2700 990 Lockable</p>	 <p>2700 990</p>	 <p>2700 990 Lockable</p>	 <p>300 990</p>
<p>17 Accordion Curtain JPY20,000</p>	<p>18 Acrylic Panel JPY22,000</p>	<p>19 Door Panel JPY22,000</p>	<p>20 Shelf Board JPY4,000</p>
 <p>300</p>		 <p>900 900 Hooks (No. 22) included</p>	 <p>W1200xD600xH940</p>
<p>21 Fascia Board JPY3,000/m</p>	<p>22 Hooks for Mesh Panel (4) JPY1,200</p>	<p>23 Mesh panel JPY6,500</p>	<p>24 Counter unit (with shelves inside) JPY10,000</p>
 <p>(A4-size, 12 racks)</p>	 <p>(A4-size, 3 racks)</p>		 <p>W1800xD600xH730</p>
<p>25 Catalogue Rack JPY5,600</p>	<p>26 Desk-top Catalogue Rack JPY1,600</p>	<p>27 Fire Extinguisher JPY4,000</p>	<p>28 Table JPY3,200</p>
 <p>W600xD600xH650</p>	 <p>Ø750xH650</p>		
<p>29 Square Table JPY2,000</p>	<p>30 Round Table JPY4,000</p>	<p>31 Folding Chair JPY640</p>	<p>32 Stacking Chair JPY3,200</p>

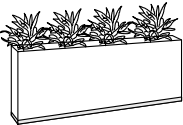
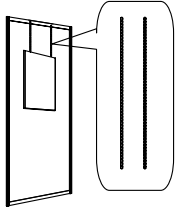
● Optional Tool ●

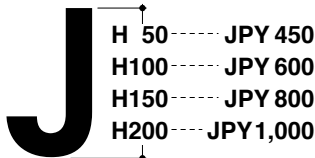

Option Tool 33-48 Rental /etc.

			 <p>The Self-standing tabletop (Video and Personal computer support) Body (1920×1080 pixels) equipped with speaker. Body size : W973×H566×D126 / ≒22kg Body size with stands : W973×H602×D270 / ≒24kg * The cost includes the rental fee for 3 days, the transportation fee, and the adjustment fee. * There is the case that the specifications may be different from the original because of the lack of the stocks. * There will be the additional charge for installation to wall. Please apply for 100V outlet (225W) separately.</p>																																				
33 High Chair JPY3,200	34 Reception Room Furniture Set JPY10,000	35 Name Card Box JPY 1,600	36 42" Wide-LCD JPY81,000																																				
 <p>W900×D450×H1800</p>	 <p>(Middle size: 100 liter.) Please apply for 100V outlet (100W) separately.</p>	 <p>The coffee maker and the coffee beans, sugar, creams, paper cups, and stirrers for 100 people Please apply for 100V outlet (1.5kW) separately.</p>																																					
37 Steel shelf JPY6,000	38 Refrigerator JPY16,000	39 The Coffee Maker & The Coffee Set JPY23,600	40 Planter(Large) JPY4,100																																				
	 <p>W1800 JPY25,300 W1300 JPY18,400 W 900 JPY12,700</p>	<table border="1"> <tbody> <tr><td>Red</td><td>No.P-1</td></tr> <tr><td>Dark blue</td><td>No.P-2</td></tr> <tr><td>Green</td><td>No.P-3</td></tr> <tr><td>Dark gray</td><td>No.P-4</td></tr> <tr><td>Orange</td><td>No.P-5</td></tr> <tr><td>Blue</td><td>No.P-6</td></tr> <tr><td>Light gray</td><td>No.P-7</td></tr> <tr><td>Yellowish green</td><td>No.P-8</td></tr> </tbody> </table> <p>* Please refer to the color sample.</p>	Red	No.P-1	Dark blue	No.P-2	Green	No.P-3	Dark gray	No.P-4	Orange	No.P-5	Blue	No.P-6	Light gray	No.P-7	Yellowish green	No.P-8	<table border="1"> <tbody> <tr><td>Cream</td><td>No.1</td></tr> <tr><td>Yellow</td><td>No.2</td></tr> <tr><td>Pink</td><td>No.3</td></tr> <tr><td>Red</td><td>No.4</td></tr> <tr><td>Light blue</td><td>No.5</td></tr> <tr><td>Blue</td><td>No.6</td></tr> <tr><td>Mint green</td><td>No.7</td></tr> <tr><td>Green</td><td>No.8</td></tr> <tr><td>Black</td><td>No.9</td></tr> <tr><td>Grain pattern</td><td>No.10</td></tr> </tbody> </table> <p>■ Monotint JPY6,000/span ■ Pattern JPY8,000/span * 1span=W990×H2700 * Please refer to the color sample.</p>	Cream	No.1	Yellow	No.2	Pink	No.3	Red	No.4	Light blue	No.5	Blue	No.6	Mint green	No.7	Green	No.8	Black	No.9	Grain pattern	No.10
Red	No.P-1																																						
Dark blue	No.P-2																																						
Green	No.P-3																																						
Dark gray	No.P-4																																						
Orange	No.P-5																																						
Blue	No.P-6																																						
Light gray	No.P-7																																						
Yellowish green	No.P-8																																						
Cream	No.1																																						
Yellow	No.2																																						
Pink	No.3																																						
Red	No.4																																						
Light blue	No.5																																						
Blue	No.6																																						
Mint green	No.7																																						
Green	No.8																																						
Black	No.9																																						
Grain pattern	No.10																																						
41 Planter(Small) JPY1,400	42 Flower box	43 Carpet (Needle punched carpet) JPY2,600/m ²	44 Coloring for Wall																																				
<p>To hung up the explanation panel, graphic panel, and so on</p>  <p>For one panel One set has two s-shaped hooks with chain.</p>  <p>For one panel One set has four Velcro tapes of 3sq mm.</p>		 <p>H 50 ----- JPY 450 H100 ----- JPY 600 H150 ----- JPY 800 H200 ----- JPY 1,000</p> <p>* Black Letter (unified font) (When you have preferred color or logo, please contact us by e-mail.)</p>	 <p>W900×H150</p> <p>* Styrene Board/Black Letter (unified font) (When you have preferred color or logo, please contact us by e-mail.)</p>																																				
45 S-shaped hooks with chain JPY 700	46 Velcro tape. JPY700	47 Cutting Letters	48 Company Name Plate JPY4,000																																				

● Optional Tool ●

Option Tool 49–55

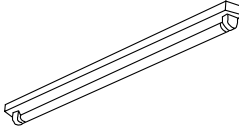
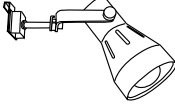
Rental

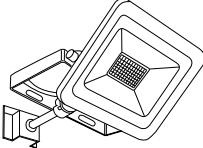
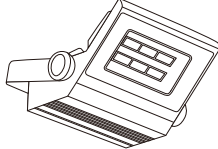
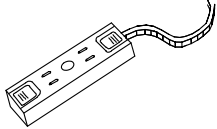
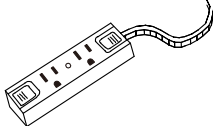
<p>* Wiring fee for trunk line and electricity charge are required separately.</p>  <p>(21W)</p>	<p>* Wiring fee for trunk line and electricity charge are required separately.</p>  <p>(15W)</p>	<p>* Wiring fee for trunk line and electricity charge are required separately.</p>  <p>(15W)</p>	<p>* Wiring fee for trunk line and electricity charge are required separately.</p>  <p>(30W)</p>								
<p>49 LED Fluorescent Light JPY3,000</p>	<p>50 LED Spot Light JPY3,000</p>	<p>51 LED Spot Light with Arm JPY3,500</p>	<p>52 LED Spot Light JPY6,000</p>								
<p>* Wiring fee for trunk line and electricity charge are required separately.</p>  <p>(60W)</p>	<p>* Wiring fee for trunk line and electricity charge are required separately.</p>  <p>★ Please indicate the capacity. (Maximum is 1.5kW per an outlet.) Please let us know if you would like 200V outlet</p>	<p>* Wiring fee for trunk line and electricity charge are required separately.</p>  <p>Please indicate the capacity. (Maximum is 1.5kW per an outlet.) Please let us know if you would like 200V outlet</p>	<p>The following construction fee of the electric panel boards will be required if the total electrical capacity exceeds over 1500W.(The fluorescent lamps in the package booth are included.)</p> <table border="1"> <thead> <tr> <th>Total Capacity</th> <th>Fee for Distribution Panel</th> </tr> </thead> <tbody> <tr> <td>less than 1,500W</td> <td>not necessary</td> </tr> <tr> <td>over 1,501W under 3,000W</td> <td>JPY6,000</td> </tr> <tr> <td>over 3,001W under 4,500W</td> <td>JPY9,000</td> </tr> </tbody> </table> <p>★ Over 3000W, it is charged 3,000 yen every additional 1,500W</p>	Total Capacity	Fee for Distribution Panel	less than 1,500W	not necessary	over 1,501W under 3,000W	JPY6,000	over 3,001W under 4,500W	JPY9,000
Total Capacity	Fee for Distribution Panel										
less than 1,500W	not necessary										
over 1,501W under 3,000W	JPY6,000										
over 3,001W under 4,500W	JPY9,000										
<p>53 LED 60W JPY10,000</p>	<p>54 100V Outlet JPY2,500</p>	<p>55 100V Outlet with ground JPY3,200</p>									

* By ordering an optional tool on this page, you also obligate to submit “Electrical work wiring diagram” in JASIS “Exhibit Service Manual” which is available on JASIS website in June; associated electrical wiring and usage fees are invoiced post JASIS.

===== Please contact us for protective equipment for COVID-19 and other infectious diseases =====

● Color Sample ●

System Panels

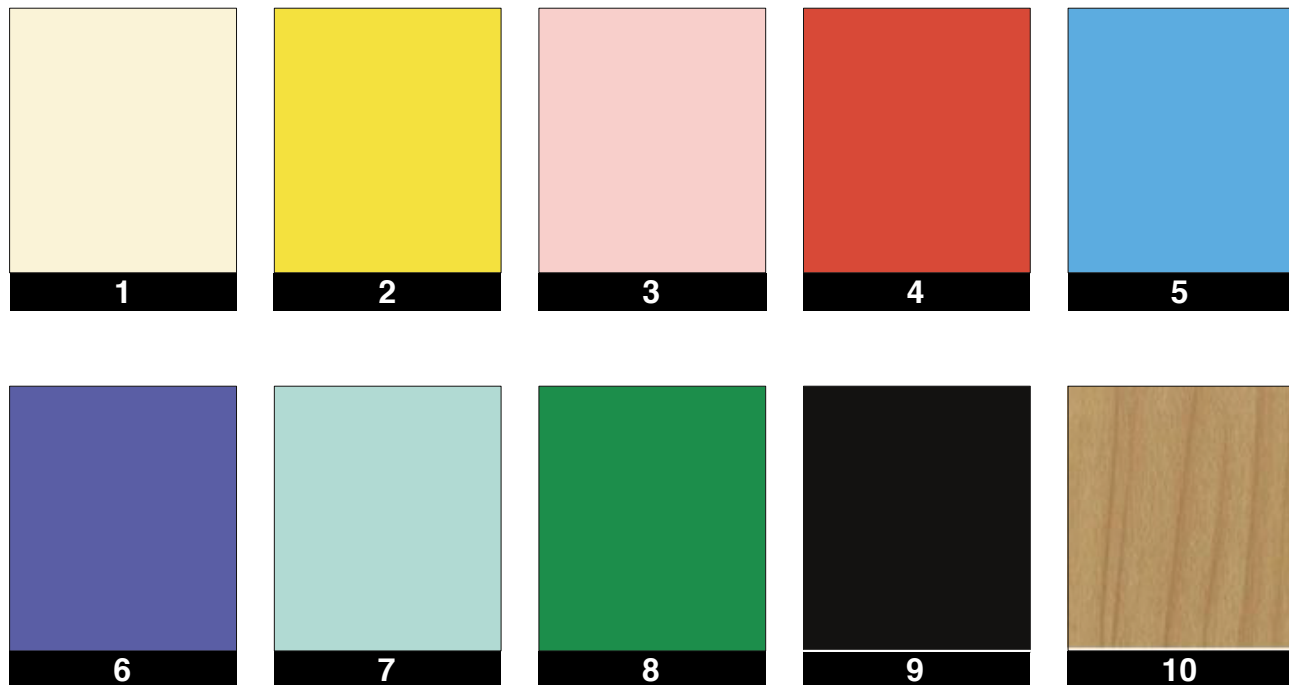

Carpet (Needle punched carpet)

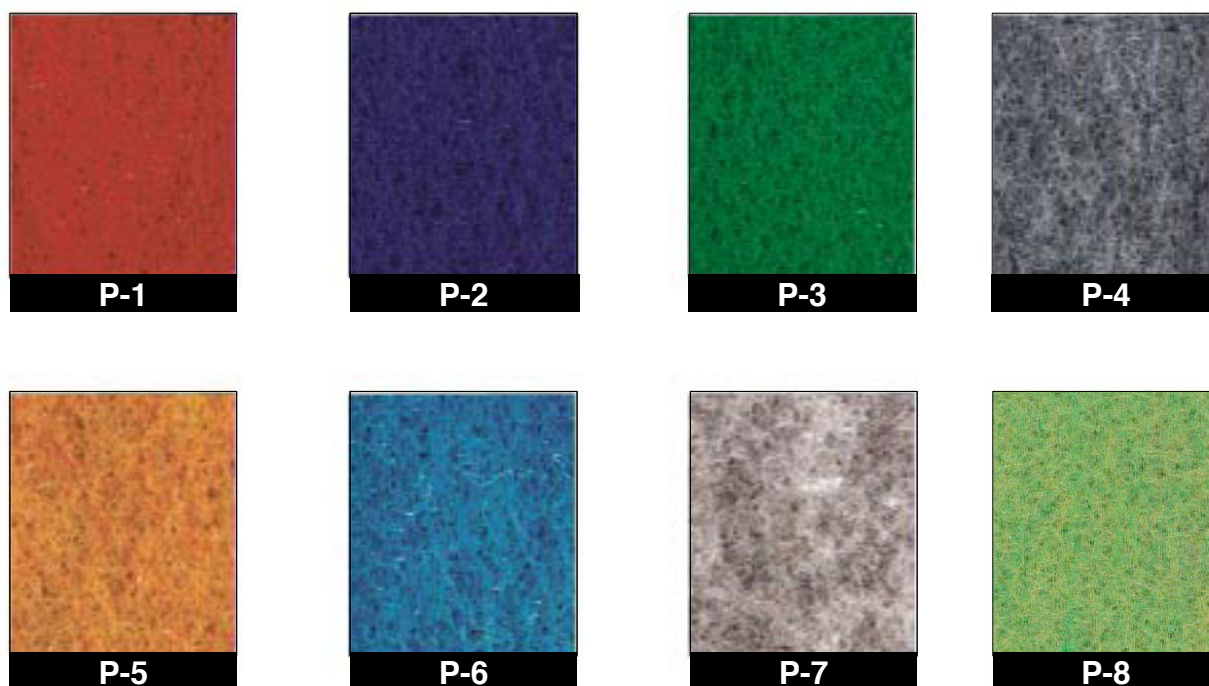

Packaged Booth Display Order Form

[Application Starts : After drawing lots] [Due Date : July 19 (Fri.), 2024]



Application date : (Month) (Day), 2024

Booth No.			
Company Name			
Department		Person in Charge	
Address			

TEL		FAX	
E-mail			

◆ Circle the No. of the packaged booth which you would like to order.

No.	Packaged Booth Display	Price
1	Packaged Booth Display 1-A (1 booth)	JPY45,400 (10% tax and entry fee excluded)
2	Packaged Booth Display 1-B (1 booth)	JPY87,880 (10% tax and entry fee excluded)
3	Packaged Booth Display 1-C (1 booth)	JPY81,200 (10% tax and entry fee excluded)
4	Packaged Booth Display 1-D (1 booth)	JPY95,600 (10% tax and entry fee excluded)
5	Packaged Booth Display 2-A (2 booths)	JPY90,800 (10% tax and entry fee excluded)
6	Packaged Booth Display 2-B (2 booths)	JPY177,600 (10% tax and entry fee excluded)
7	Packaged Booth Display 2-C (2 booths)	JPY201,300 (10% tax and entry fee excluded)
8	Packaged Booth Display 2-D (2 booths)	JPY209,580 (10% tax and entry fee excluded)
9	Packaged Booth Display 3-A (3 booths)	JPY136,200 (10% tax and entry fee excluded)
10	Packaged Booth Display 3-B (3 booths)	JPY282,500 (10% tax and entry fee excluded)
11	Packaged Booth Display 3-C (3 booths)	JPY299,040 (10% tax and entry fee excluded)
12	Packaged Booth Display 3-D (3 booths)	JPY306,200 (10% tax and entry fee excluded)

* All indicated prices exclude tax and entry fee. By ordering a packaged booth plan, you also obligate to submit "Electrical work wiring diagram form" in JASIS "Exhibit Service Manual" which is available on JASIS website in June; associated electrical wiring and usage fees are invoiced post JASIS.

◆ Selection of the color of the carpet 《Mandatory》

Circle the color No. of the carpet which you would like to order. *Please refer to the color sample

No.	P-1	P-2	P-3	P-4	P-5	P-6	P-7	P-8
-----	-----	-----	-----	-----	-----	-----	-----	-----

◆ Put a check mark in the box below depending on necessity.

In addition to the above packaged booth, we would like to order optional tools.

(When you put a check mark in the above box, please fill in the attached "Optional Tool Order Form")

Submit order form to	<p>Ten Co.,LTD. Address: Morimitu Shinkou Bldg.9F,5-9, Kotobuki 1-chome, Taitou-ku, Tokyo 111-0042 Japan Fax : +81-3-3842-7720 E-mail : jasis@teninc.co.jp ★ I apologize for bothering you, but please contact us by E-mail</p>
----------------------	---

Booth No.	Company Name		
Address			FAX
Department	Person in Charge	E-mail	
Submit order form to	Ten Co.,LTD. Address : Morimitu Shinkou Bldg.9F,5-9, Kotobuki 1-chome,Taitou-ku, Tokyo 111-0042 Japan Fax : +81-3-3842-7720 E-mail : jasis@teninc.co.jp		

- If you also submit the attached “Packaged Booth Display Order Form”, put a check mark in the box at right. →→→
- Please indicate preferable location of each item and the capacity and location of outlet when using the electrical power supply.

<div style="border: 1px dashed gray; width: 100%; height: 100%;"></div>	<p style="text-align: center;">[Layout Example]</p>
---	---

● Option items

No.	Items	Q'ty	Price	Charge	Note	No.	Items	Q'ty	Price	Charge	Note	
1	Wall Panel (W990xH2700)		6,500			32	Stacking Chair		3,200			
2	Wall Panel (W700xH2700)		5,500			33	High Chair		3,200			
3	Wall Panel (W495xH2700)		5,500			34	Reception room Furniture Set	Set	10,000			
4	Reception Counter (W990xD495xH1000)		12,000			35	Name Card Box		1,600			
5	Display Platform (W495xD495xH750)		6,000			36	42" Wide-LCD		81,000			
6	Display Platform (W700xD495xH750)		7,000			37	Steel shelf (W900xD450xH1800)		6,000			
7	Display Platform (W990xD495xH750)		8,000			38	Refrigerator (Middle size: 100 liter)		16,000			
8	Display Platform (W700xD700xH750)		9,000			39	The Coffee Maker & The Coffee Set		23,600			
9	Display Platform (W990xD700xH750)		11,000			40	Planter (Large)		4,100			
10	Display Platform (W990xD990xH750)		14,000			41	Planter (Small)		1,400			
11	Cabinet (W990xD495xH750)		10,000			42	Flower box W1800		25,300			
12	Cabinet (W990xD700xH750)		13,000			42	Flower box W1300		18,400			
13	Cabinet (W990xD990xH750)		16,000			42	Flower box W900		12,700			
14	495R Display Platform (W495xD495xH750)		8,000			43	Carpet (Needle punched carpet)	m ²	2,600		Color (No. :)	
15	Corner Display Platform (W990xD990xH750)		16,000			44	Coloring for Wall (Monotint)	span	6,000		Color (No. :)	
16	495L Display Platform (W495xD495xH750)		6,000			44	Coloring for Wall (Grain Pattern)	span	8,000		No. 10	
17	Accordion Curtain		20,000			45	S-shaped hooks with chain		700			
18	Acrylic Panel		22,000			46	Velcro tape		700			
19	Door Panel (Lockable)		22,000			47	Cutting Letters H50	letter	450			
20	Shelf Board (W990xD300)		4,000			47	Cutting Letters H100	letter	600			
21	Fascia Board	m	3,000			47	Cutting Letters H150	letter	800			
22	Hooks for Mesh Panel (4)	Set	1,200			47	Cutting Letters H200	letter	1,000			
23	Mesh panel (W900xH900)		6,500		Hooks (No. 22) included	48	Company Name Plate (W900xH150)		4,000			
24	Counter unit (W1200xD600xH940)		10,000		(with shelves inside)	49	LED Fluorescent Light (21W)		3,000			
25	Catalogue Rack (A4-size, 12 racks)		5,600			50	LED Spot Light (15W)		3,000			
26	Desk-top Catalogue Rack (A4-size, 3 racks)		1,600			51	LED Spot Light with Arm (15W)		3,500			
27	Fire Extinguisher		4,000			52	LED Spot Light (30W)		6,000			
28	Table (W1800xD600xH730)		3,200			53	LED (60W)		10,000			
29	Square Table (W600xD600xH650)		2,000			54	100V Outlet		2,500		electric capacity (W)	
30	Round Table (Ø750xH650)		4,000			55	100V Outlet with ground		3,200		electric capacity (W)	
31	Folding Chair		640			Total						

* All indicated prices exclude tax and entry fee. By ordering an optional tool which requires electricity supply, you also obligate to submit “Electrical work wiring diagram form” in JASIS “Exhibit Service Manual” which is available on JASIS website in June; associated electrical wiring and usage fees are invoiced post JASIS.