



# JASIS

Japan Analytical & Scientific Instruments Show

# 2019

**Exhibit  
Service Manual**  
<https://www.jasis.jp/en/>

**[Exhibit Service Manual] is also available on  
JASIS 2019 website : <https://www.jasis.jp/en/>**

---

**Please ask your decorator to read this [Exhibit Service Manual] carefully  
before their design and construction!**



Japan Analytical Instruments Manufacturers' Association



Japan Scientific Instruments Association

# — Table of Contents —

<b>Access to Exhibition Site</b> .....	2
<b>Layout of the venue</b> .....	3
<b>Overview</b> .....	4
<b>Overall Timetable</b> .....	5
<b>General Information</b> .....	6-9
1. JASIS Secretariat Office 2. Accident prevention and exhibitor responsibility	
3. Prevention exhibition display theft 4. Prohibition of abandoning exhibition displays	
5. Handling of foreign goods with bonded exhibition 6. Prohibition of display of counterfeit products	
7. Exhibition displays of inventions prior to application for industrial property rights (request for exhibition verification)	
8. Overtime work 9. Exhibitors' Tags 10. No photography policy	
11. Displays and expressions in booths (including presentations)	
12. Restricted activities 13. Precautions for collecting personal information 14. Disposal of wastes	
15. Meal and beverage vouchers 16. Others	
<b>New Technology Seminars</b> .....	10-12
1. Overview 2. Capacity & Equipments 3. Operation of New Technology Seminars	
4. Cancellation of presentation or change of topic after manuscript submission 5. Photographing, video and audio recordings and their public releases 6. Other Restricted Actions	
<b>Exhibit Guidelines</b>	
<b>1. Installation and Dismantling (I&amp;D)</b> .....	13-14
(1) I&D time frame (2) I&D by vehicle (3) I&D vehicle routing	
(4) Delivery of exhibits to booth using Parcel delivery service (5) I&D on show dates	
(6) Exhibitors entering the venue during show dates (7) Wastes (8) Others	
<b>2. Exhibition and Decoration</b> .....	15-22
(1) Stock space (2) Booth locations (3) Booth specification	
1) Basic Booth (Row, Opposing rows, Block) .....	15
2) Independent Booth 3) Construction.....	16
(4) Booth Decoration	
1) Registration of decoration contractors 2) Construction and dismantling dates .....	16
3) Disposal of waste materials .....	17
(5) Construction Reminders	
1) Reminders for system panel booths 2) Parapet display .....	17
3) Prohibition of carpeting passages 4) When installing doors which open onto walkways	
5) Arranging exhibit objects 6) Construction of ceiling or two-floor structures .....	17
7) Prohibition of direct fabrication 8) Loading & Unloading by Vehicles	
9) Decorating materials .....	18
10) Height restrictions on decoration .....	18-19
11) Openings on the structures facing aisle side & evacuation passage .....	20
12) Regulations on presentations within the booth and noise prevention .....	20-22
13) Floor work .....	22
<b>3. Electricity</b> .....	23-24
(1) Applying for power supply (2) Power specifications (3) Electrical installation costs	
(4) Electricity charges (5) Reminders regarding electric installation work within your booth	
(6) Hours of power supply to your booth (7) 24-hour power supply (8) Others	
<b>4. Fire Safety</b> .....	25
(1) Fire Inspection (2) No smoking policy (3) Use of open flames and hazardous substances (4) Other reminders	
<b>5. Phone/ADSL/ISDN/Optical Fiber connection</b> .....	26
(1) Application (2) Charges (3) Notification of phone number (4) Others	
<b>6. Water Supply, Drainage, Compressed Air</b> .....	27
(1) Water supply and Drainage (2) Compressed Air (3) Town Gas (4) Notes	
<b>7. Rental Meeting Rooms and Lounges</b> .....	28
<b>8. Servicing Foods or Beverages</b> .....	29
<b>■ List of Forms, Applications and Submission Deadlines</b>	
1. Decorator Registration Form	
2. Application for Special Construction	
3. Light and Power Installation Blueprint	
4. Application for Meeting Rooms and Guest Lounges rental	
5. Application for the Use of Open Flames and Hazardous Substances	
6. Application for Water Supply, Drainage, Compressed Air & Town gas	
7. Application for Change of Address or Number of Tags for Exhibitors & Contractors	
8. Confirmation Request for Products Needing Application for Industrial Property Right	
9. Notification of Foods & Beverages Service	
10. Application for Temporary Phone, ADSL and Optical Fiber connection	
11. Application for the Use of Drayage Machinery	
12. Request form for dispatch of interpreters and reception staff	
13. Visa Application	
<b>■ List of contact addresses of the Show Office and Organizer designated Contractors</b>	

## Access to Exhibition Site

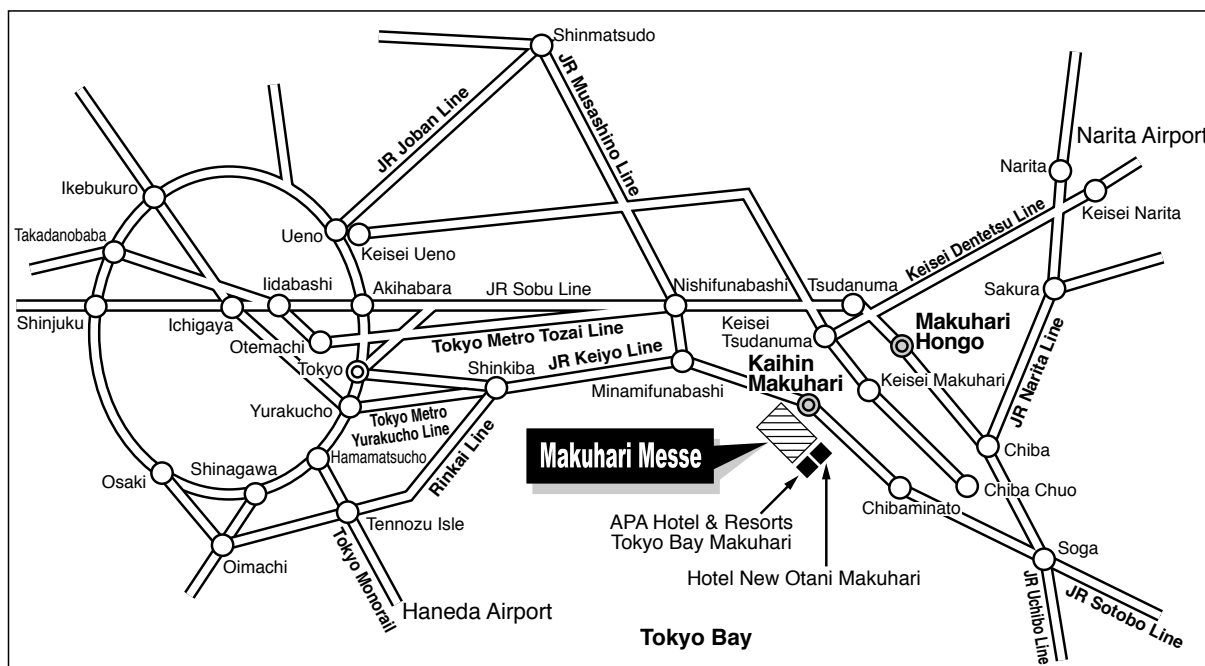

### ■ By train:

From Central Tokyo

- Take the JR Keiyo Line to Kaihin Makuhari Station. (approx. 30 minutes from Tokyo Station and approx. 12 minutes from Soga Station by express train). Makuhari Messe is about a 10 minute walk from the station.
- Take the JR Sobu Line to Makuhari Hongo Station. (approx. 40 minutes from Akihabara Station, approx. 80 minutes from Yokohama station). Makuhari Messe is about a 15 minute bus ride from the Makuhari Hongo station.

### ■ By air:

Nearby major international airports are Narita (New Tokyo) International Airport and Haneda (Tokyo) International Airport.

From Narita Airport (New Tokyo International Airport)

- Take the airport limousine bus service, either Keisei Bus or Chiba Commuter Bus, approx. 30 minutes from Narita Airport to Makuhari Messe area hotels.
- Take Keisei Line (train) to Tsudanuma, transfer to Keisei Chiba Line to Makuhari Hongo (approx. 53 minutes), then take Keisei Bus to Kaihin Makuhari (approx. 15 minutes) or take a taxi.

From Haneda Airport

- Take Keisei airport limousine bus service, approx. 40 mins from Haneda Airport to Makuhari Messe and its nearby hotels.

**A shuttle bus service is available between the show venue and Makuhari Hongo Station via Kaihin Makuhari Station. Buses are free of charge and run every 5 to 10 minutes.**

Note: Some buses do not stop at Kaihin Makuhari Station.

Please visit our official website at <http://www.jaimasis.jp/english/index.html> for details.

### ■ Free direct bus transportation is available from the Kashima and Tsukuba districts.

### ■ By car: (Public means of transportation is, however, recommended.)

From Central Tokyo

- Take the Higashi-Kanto express toll way to Wangan-Chiba Junction (approx 40 minutes from both downtown Tokyo and the Tokyo International Airport at Haneda. About 5 minutes from the junction following the signs to “Makuhari-Messe”.

Note: Parking lots are all pay lots.

Please refer to the website of makuhari-Messe and the following map for parking information:

[http://www.m-messe.co.jp/access/parking\\_e.html](http://www.m-messe.co.jp/access/parking_e.html)

**Layout of the venue**

- [JASIS\_ New Technology Seminars] Room Section #1  
**APA Hotel & Resort Tokyo Bay Makuhari (2nd floor)**  
**Tokyo Bay Makuhari Hall, Rooms No. A-1 to A-11**

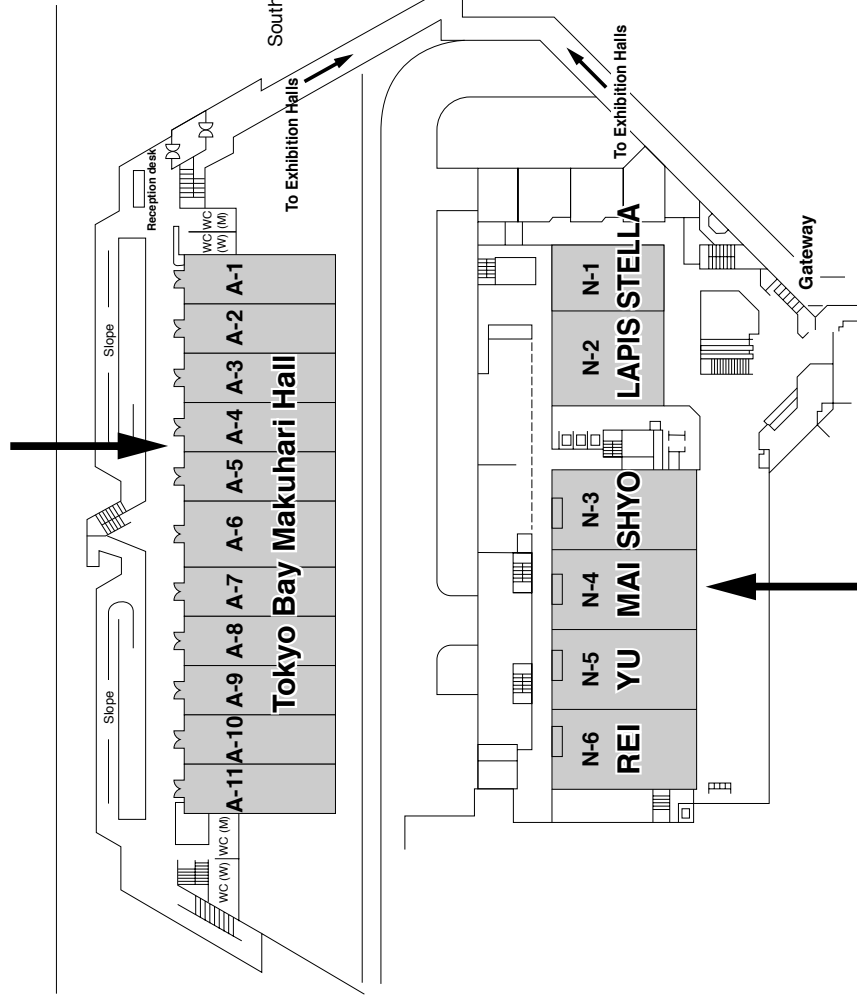

- [JASIS\_ New Technology Seminars] Room Section #2  
**Hotel New Otani Makuhari, 2nd Floor**  
**STELLA(N-1), LAPIS(N-2), SHYO(N-3), MAI(N-4),**  
**YU(N-5), REI(N-6)**

● [JASIS 2019]

- **Hall 4, 5, 6, 7 and 8 in the Makuhari Messe International Exhibition Hall**

- Life Science Innovation Zone
- Open Solution Forum
- mini / Solution Area
- mini / Solution Exhibition Area
- mini / Solution Catalogue Area
- Research Organization Area
- Academic Association Area
- International Organization Area (U.S. Pavilion, etc.)
- Media & Press Area

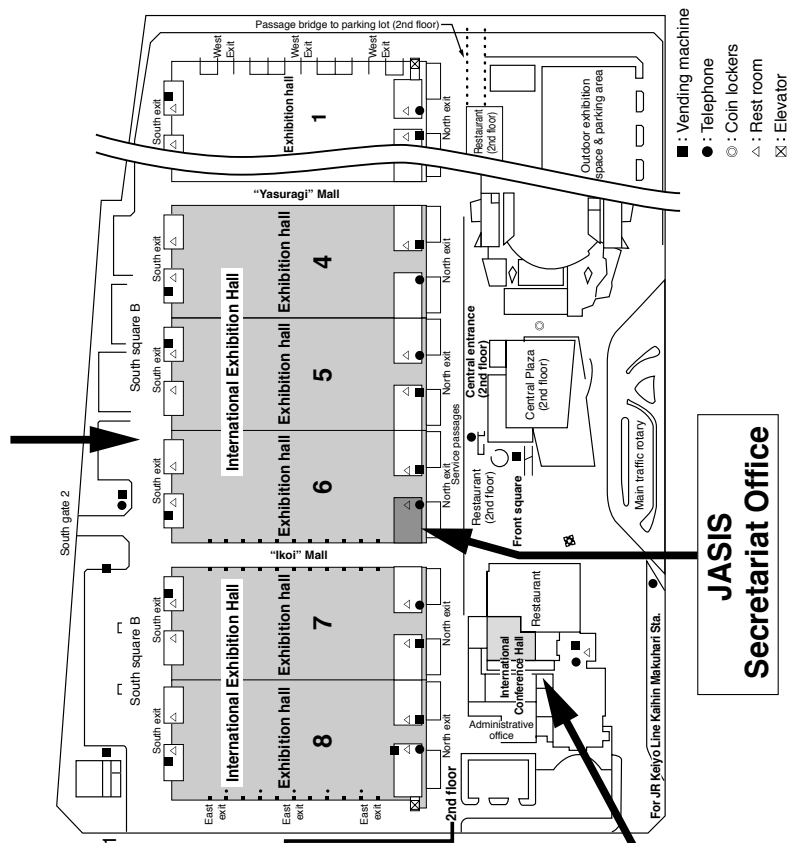

- [JASIS Conferences] International Conference Hall in Makuhari Messe

---

# Overview

---

<b>Title</b>	JASIS 2019
<b>Organizers</b>	Japan Analytical Instruments Manufacturers' Association (JAIMA) Japan Scientific Instruments Association (JSIA)
<b>Sponsors (planned)</b>	Ministry of Economy, Trade and Industry / Ministry of Education, Culture, Sports, Science and Technology / Ministry of Environment Japan Society for Analytical Chemistry / Chemical Society of Japan and others
<b>Public Relations:</b>	• Internet • Newspaper, magazines, posters • Delivery of programs to the visitors in advance • On-site advertisement using public announcements and bulletin boards
<b>Admission Fee</b>	Free

## • JASIS 2019

Dates	September 4 - September 6, 2019 (3 days, Wed.- Fri.)
Time	10:00 - 17:00
Venue	International Exhibition Halls Nos. 4, 5, 6, 7 and 8 in Makuhari Messe 2-1 Nakase, Mihama-ku, Chiba zip code 261-8550, Japan URL: <a href="https://www.m-messe.co.jp/">https://www.m-messe.co.jp/</a>

## • Concurrent Event: New Technology Seminars

Dates	September 4 - September 6, 2019 (3 days, Wed. - Fri.)
Time	10:30 - 16:30
Venue	Venue (adjacent to exhibition halls, planned): Tokyo Bay Makuhari Hall, APA Hotel & Resorts Tokyo Bay Makuhari Hotel New Otani Makuhari

## • Concurrent Event: JASIS Conferences

Dates	September 3 - September 6, 2019 (4 days, Tue. - Fri.)
Time	10:00 - 17:00
Venue	International Conference Hall, Makuhari Messe

## • Special Program: Life Science Innovation Zone (LSZ)

Dates	September 4 - September 6, 2019 (3days, Wed. - Fri.)
Time	10:00 - 17:00
Venue	Exhibition Hall in Makuhari Messe

## • Special Program: Open Solution Forum

Dates	September 4 - September 6, 2019 (3 days, Wed. - Fri.)
Time	10:30 - 15:50
Venue	Exhibition Hall in Makuhari Messe

# Overall Timetable

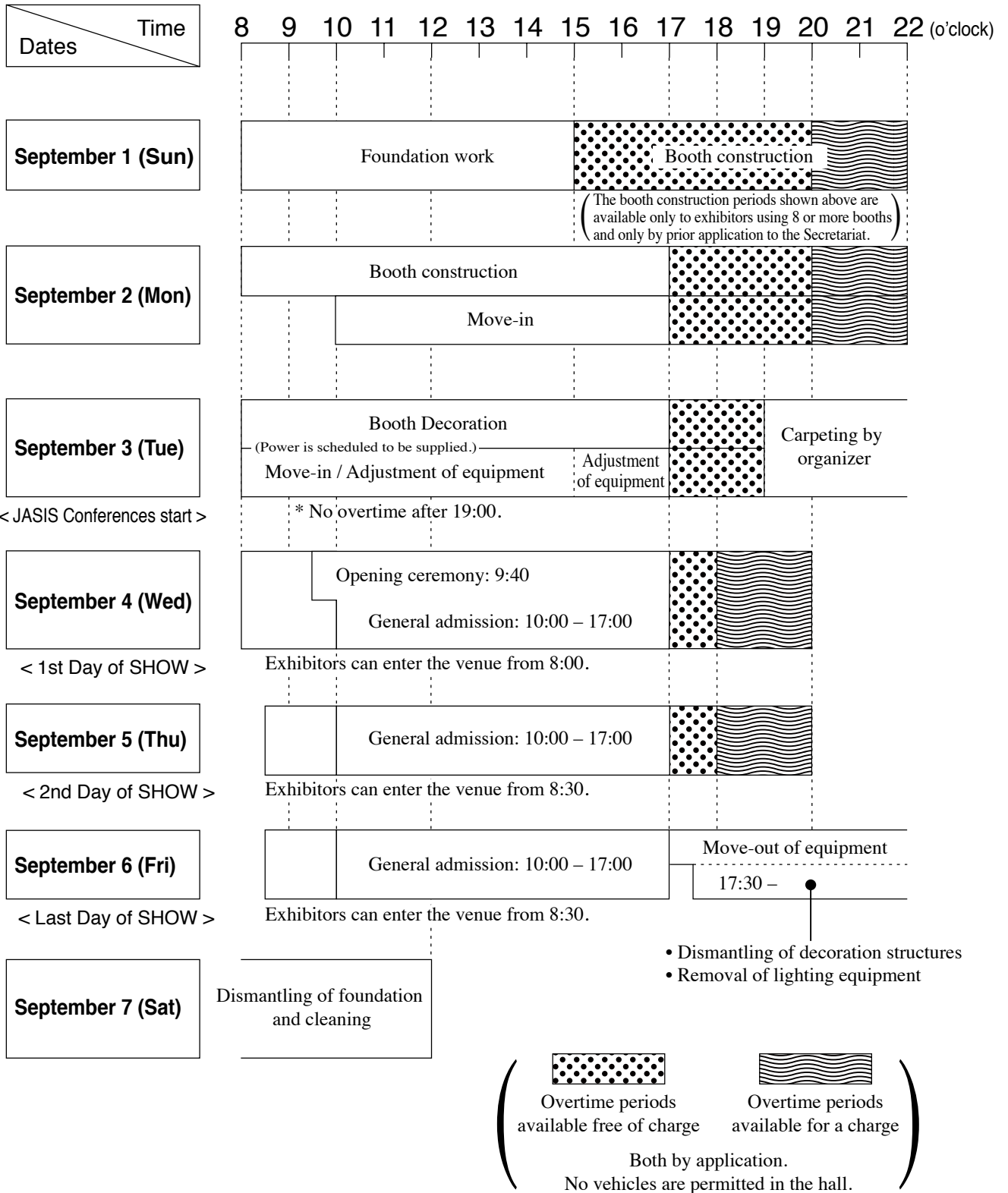

---

# General Information

---

## 1. JASIS Secretariat Office

---

- 1) For safe and smooth operation and for maintaining order in this show, all participating companies and organizations are requested to comply with show regulations and to follow the instructions issued by the Secretariat Office. Your cooperation is highly appreciated.
- 2) From (Mon.) September 2 through (Fri.) September 6, 2019, the JASIS Secretariat Offices will be set up in the north office of the International Exhibition Hall 6, Makuhari Messe. The Office will be in charge of show management and maintenance and of an information service to facilitate its smooth operation and the convenience of its exhibitors and guests.

Office address: International Exhibition Hall 6, Makuhari Messe

Nakase 2-1, Mihama-ku Chiba-city, zip 261-8550

A direct phone line will be available from (Mon.) September 2, 2019.

## 2. Accident Prevention and Exhibitor Responsibility

---

- 1) Exhibitors are expected to take maximum caution to prevent any accident throughout the show dates.
- 2) The organizer reserves the authority to limit or stop any exhibitor's operation for the purpose of accident prevention.
- 3) Exhibitors, including their contractors and representatives, are expected to take responsibility for any damage or harm made to the venue facilities, structures, and any person during the entire course of the exhibition.
- 4) If the JASIS 2019 organizers decide that the management of the exhibit or the exhibit's content is detrimental to the success of the exhibition, the exhibitor will be instructed to cease the inappropriate activity and/or remove the objectionable object.

## 3. Prevention exhibition display theft

---

- 1) The Secretariat Office will provide security guards in the venue during the show. However, the control of exhibits (Especially bags, mobile devices and PCs, valuables, and personal effects including private information) is exhibitors' responsibility.

In no event will JASIS 2019 or Secretariat Office be held liable for damaged, stolen, lost, or broken exhibits (including personal belongings).

- 2) In order to avoid theft, exhibitors are requested to take responsibility for managing valuable items by, for example, bringing back or storing them in their own space in the booths.
- 3) The exhibitors are advised to obtain necessary insurance for their exhibits on their own responsibility.
- 4) Exhibitors, who want to use a security service for their own booths (at a charge) from the preparation period to the show period, should directly consult and apply to TEXS Corporation, the security company responsible for guarding the show venue. Please note that the Organizer is not involved in any security contracts between the exhibitors and TEXS Corporation.

(F.Y.R: Labor Charge: 2,500 JPY/hour (excludes tax & expense). For details, please ask TEXS Corporation as follows)

**TEXS Corporation**

Sun Youth Bl. 3rd floor, 5-40-9 Higashi-Ikebukuro, Toshima-ku, Tokyo 170-0013, Japan

Phone: +81-3-3590-6446 Fax: +81-3-3590-4001

Email: ikegami@texs.co.jp

## 4. Prohibition of abandoning exhibition displays

---

During the exhibition period, dismantling of exhibition products and decorations and leaving booths unmanned are prohibited. The Mini Solution catalogue area is excepted.

## 5. Handling of foreign goods with bonded exhibition

1) We filed an application to obtain permission for the JASIS 2019 to be a bonded exhibit area. Foreign exhibits (goods) can be displayed with no duty by declaring the goods for exhibition to the customs office and by obtaining authorization from the customs.

When you distribute brochures and/or pamphlets from abroad during the show, be sure to get an import approval for goods prior to bringing them into the show venue.

2) ISHIKAWA-GUMI. LTD. (see below) shall be ready to submit all of your application paper works to the customs office to obtain exhibit approval at the JASIS 2019.

For details of handling foreign exhibits, follow the instructions given by ISHIKAWA-GUMI. LTD., in addition to the descriptions in this manual.

<p><b>ISHIKAWA-GUMI, LTD.</b> (Contact : Ms. Hasegawa) 4-14-2 Higashi-Ooi, Shinagawa-ku, Tokyo 140-0011, Japan Phone: +81-3-3474-8102 Fax: +81-3-5460-9841 Email: m_hasegawa@ishikawa-gumi.co.jp</p>
--

## 6. Prohibition of display of counterfeit products

Exhibition of displays that infringe on intellectual property rights is prohibited.

## 7. Exhibition Displays of Inventions Prior to Application for Industrial Property Rights

JASIS 2019 is authorized as a “Designated Exhibition” by the Japan Patent Office. Therefore, the exception to Lack of Novelty may be applicable to products you exhibit (3rd paragraph of Article 30 of the Japanese Patent Law, 1st paragraph of Article 11 of the Japanese Utility Model Law, and 1st paragraph of Article 9 of the Japanese Trade Mark Law). Exhibitors planning to exhibit products before submitting an application for industrial property rights and intending to apply for an Exhibit Certificate for JASIS 2019, are required to submit “Confirmation Request for Products Needing Application for Industrial Property Rights” (Form 8) to the Secretariat. (Submission deadline: July 26, 2019)

Based on those requests, the Secretariat will examine and confirm the exhibitor's exhibition products during the show. The Exhibit Certificate shall be issued and given to exhibitors upon request within seven days after the show. Please note that simply submitting the application document (Form 8) does not constitute completing the application for the Exhibit Certificate.

For more details, please consult the Secretariat.

Note: This exemption is merely a measure for exceptional cases, therefore, completion of the Industry Property Rights application process is highly recommended before exhibiting such products at the show.

## 8. Overtime work

Please notify the Secretariat Office at Makuhari Messe hall 6 in advance or on that day when the exhibitor must work overtime. (This is to secure necessary arrangements for power supply, air conditioning, security, and other necessities.)

¥51,300 per hour per exhibitor will be charged for overtime work performed during fee-based overtime periods. (Please see “Overall Timetable” on page 5 for details of the overtime hours.)

## 9. Exhibitors' Tags

Tags for exhibitors shall be provided and sent out to exhibitor contact addresses in the beginning of August. (These tags are issued to prevent entry of unauthorized persons into the show venue.) All staff members and booth attendants must wear tags provided at all times.

5 tags per 1 booth block shall be sent to contact addresses in the beginning of August.

Note: When you require to change the number of the tags and the address to be sent, please apply by filling out Form 7: Application for Change of Address or Number of tags for Exhibitors (Deadline: July 5, 2019).



## **10. No photography policy**

Taking photographs and videos are prohibited in the venue, except for personnel holding a permit issued by JASIS secretariat. The no photography policy includes the case of personnel or other people related to an exhibitor taking photographs of their own booths, except for those holding a permit issued by the Secretariat. (Permits will be issued at the JASIS secretariat Office in the International Exhibition Hall 6, Makuhari Messe.) When visitors or personnel of other exhibitors are found taking photographs and videos without permission, they shall be stopped immediately.

Displaying appropriate cautions in your booth or at the seminar to prevent unauthorized shootings is recommended. Please, give a credit to “JASIS 2019” when you release images taken at JASIS 2019 to the public. Releasing the images taken at JASIS 2019 exhibit is totally exhibitors’ own risks and responsibility. Please, respect each individual’s legal or portrait rights when you take images. JASIS takes NO responsibility for any actions caused.

## **11. Displays and expressions in booths (Including presentations)**

Please refrain from using displays and/or expressions that would compromise the integrity of our associations. Please do not make presentations using bursting sound, lights, or smoke which other exhibitors and visitors might mistake for an accident or an emergency. In addition, we ask booth attendants to refrain from wearing inappropriate clothing which is not consistent with common sense and social standards. For details, please refer to pages 20 to 22.

## **12. Restricted activities (Blocking of Traffic outside of booth)**

In passages in the venue, including the doorways and escalators, exhibitors are restricted from any activity which disturbs free traffic of visitors, including but not limited to distributing leaflets and/or questionnaires, and calling visitors into your booths. We have received numerous complaints about the blocking of traffic by promotional staffs who distribute questionnaires; we request that exhibitors employing such staffs provide them strict instructions. Please utilize your own booth space.

## **13. Precautions for collection of personal information**

1) Personal information should be acquired with visitor’s agreements on exhibitor’s responsibilities according to Japanese personal information protection law. The following explanations should be indicated clearly to the visitors.

- Clear indication of intended use, prohibition of use other than that intended.
- Non-disclosure to third parties (exceptions must be clearly indicated)
- Management system (measures for security and against loss, misuse, alteration, and leakage)

2) Groups with no relationship to JASIS have been observed both inside and outside of the venue trying to obtain personal information through exchange of business cards. With some of them putting on the appearance of visiting customers, it is extremely difficult to completely eliminate their presence. Because their actions can lead to disturbance and personal information leaks, in addition to the organizers posting warning signs and making warning announcement, security guards will also provide warnings. We suggest exhibitors to take precautions.

If you find those behaviors please notify JASIS organizers.

## 14. Disposal of wastes

---

Please be sure to remove all residual materials and waste in your booth. Please ask decorators and transport companies to remove all waste. In addition, for the disposal of waste during the show, three collection boxes for recyclable, flammable and nonflammable waste is installed near the restrooms at the north side of each hall.

## 15. Meal and beverage vouchers

---

If you would like to purchase meal and beverage vouchers, you can obtain them as follows.

(For details, please make inquiries to Makuhari Messe, Inc.)

- 1) Preordering with a bank transfer, please fax the following form up to one month before the show:  
[https://www.m-messe.co.jp/en/docs/newcityguide/meal\\_ticket\\_shoplist.pdf](https://www.m-messe.co.jp/en/docs/newcityguide/meal_ticket_shoplist.pdf)

(The website of Makuhari Messe, Inc.)

- 2) During the show (cash only)

You can purchase meal tickets at the reception counter of the International Conference Hall in Makuhari Messe from 9:00 to 17:00 during the show.

**Makuhari Messe, Inc.**

Nakase 2-1, Mihama-ku, Chiba City, Chiba, 261-8550 Japan

Phone: +81-43-296-0525 Fax: +81-43-296-0529

## 16. Others

---

### 1) Copy, Fax:

Copy and fax machines are available with charges at International Conference Central Hall 2F in Makuhari Messe.

### 2) Wireless Internet:

Free Wi-Fi is available at the Common Spaces inside the exhibition venue.

Please refer below regarding how to connect to Makuhari Messe Common Spaces Wi-Fi.

<https://www.m-messe.co.jp/en/facility/>

### 3) Video and Photo shootings by JASIS Office

JASIS organizer may shoot images and videos during the Exhibiton.

### 4) Dispatch of Reception Staff and Interpretater

Exhibitor can choose any companies who provide the dispatch. The Form 12 at the end of this service manual also provides the service.

---

# New Technology Seminars

---

## 1. Overview

**(1) Dates/Time:** September 4 (Wed.) - September 6 (Fri.), 2019, 10:30 - 16:30

**(2) Presentation time:** 25 or 50 minutes including Q&A session

**(3) Venue**

Venue A: Tokyo Bay Makuhari Hall, APA Hotel & Resorts Tokyo Bay Makuhari (adjacent to show venue, planned)

Venue N: Hotel New Otani Makuhari (adjacent to show venue, planned)

## 2. Capacity & Equipments

1) 12 rooms with a capacity of 100 people and 5 rooms with a capacity of 200 people. Requests for 200 capacity rooms need to be submitted with the application.

Sessions may be assigned a 200 capacity room even though not requested. Also, room assignments for presentations might differ from those announced in advance.

\*In order to ensure safety in the case of an emergency, attendee entrance shall not exceed capacity.

2) PCs with your presentation data should be prepared by yourself. Please, prepare and bring your presentation backup data for just in case scenario.

3) In each room, a podium, desk for the lecturer, chair, microphones, speakers, \*LCD projector, reception desk, table for equipment demonstration and power supply (with one AC 100 V, 50 Hz, 1.5 kW outlet) are available. All lost items should be compensated at actual expenses. Each presenting company should prepare their own laser pointer. In case of malfunction on the day of the presentation, a pointer may be borrowed from the organizers.

Projector has two cables. See the figure below.

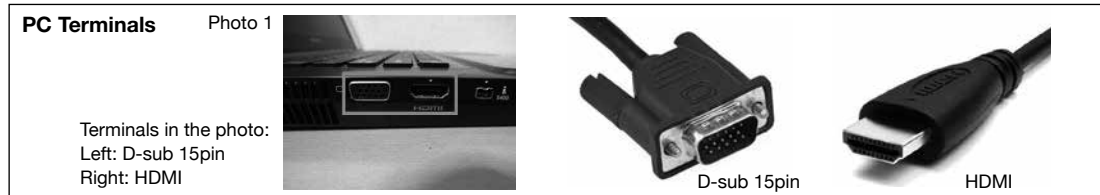

\*The following Projectors and the Screens are set up according to the sizes of the following rooms for improving the ease of viewing screen. (Aspect Ratio of all Screens is 4 : 3 )

Room Number: A-1/A-2/A-3/A-4/A-5/A-7/A-8/A-9/A-10/A-11/N-1  
Projector EB-950WH 3000lm and 100 inch Screen

Room Number: N-2/N-3/N-4/N-5/N-6/A-6  
Projector EB-L1100U 6000lm and 150 inch Screen

Note: Exhibitors are requested to supply their own OHP and video machines if required.

- 4) Questionnaires, and consecutive interpreters are to be arranged by the exhibitors if required.
- 5) We will provide a room where you can run the connectivity test between the LCD projector we provide and your PCs in advance. If you would like to test your equipment in advance, take account of the congestion in the test room, and please make sure to finish the test one day before your presentation or at latest 30 minutes before.

### 3. Operation of New Technology Seminars (Important)

The organizers will provide assistance by stationing committee staff at the venue. However, presenters are requested to be responsible for the operation of their sessions by observing the rules and regulations bellow.

#### (1) Observing the room capacity

- 1) Exhibitors are requested to observe room capacities (100 or 200 people). For emergency safety purposes, holding a seminar with people exceeding the capacity and with people standing in the room is strictly prohibited. We appreciate your understanding and cooperation.

When the audience is expected to exceed 100 people, please apply for a 200 capacity room. The organizers will place priority on such sessions in assigning 200 capacity rooms. (Session fees will not vary according room capacities.)

- 2) It is the responsibility of each presenting company to take appropriate measures to ensure its presentation documents are delivered to those who were turned away due to full occupancy.

#### (2) Observing time schedule and program contents

- 1) Keep your presentation within the allotted time of either 25 or 50 minutes. This allotted time includes lecture, Q&A session, collecting questionnaires, and vacating the room. If the presentation time exceeds the scheduled period, the organizing committee may order the immediate cessation of the session.
- 2) Presenters and reception staffs must be available by the reception desk at the designated room 20 minutes prior to the scheduled starting time.
- 3) Reception staff shall vacate the position 5 minutes prior to session closure.

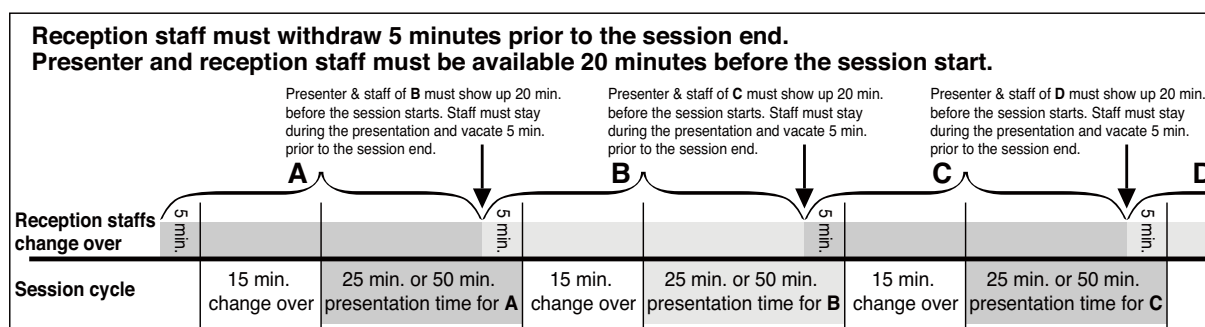

#### (3) Reception management and maintaining a queue at the reception area

- 1) Receptionists and assistants are to be provided by the presenters.  
The organizers will assign 1 to 3 personnel to support smooth operation in the reception area. However, presenters are to be fully responsible for the reception operation. This includes managing safety, strictly distinguishing competitors, and management of questionnaires, business cards, and valuables.
- 2) If you expect congestion at the reception counter in the room, please take measures such as increasing the number of receptionists.
- 3) Reception staff is expected to be ready 20 minutes prior to the session start time, stay during the presentation. Then, withdraw 5 minutes before the scheduled ending time to enable smooth transitions. If the reception staff is late, the organizers may allow the audience to enter the room to avoid congestion in the reception area.

#### (4) Non-Japanese Presentations

- 1) Presentation language and translation

If your presentation language is neither English nor Japanese, you need to arrange an interpreter by your own.

To notify spectators, you shall specify your presentation language and translation availability in your presentation manuscript if your presentation is not in Japanese.

- 2) When simultaneous interpretation is required, a pre-fixed room with equipment and an interpreter will be arranged by the organizers.  
(For sessions with consecutive interpretation, the presenter is expected to arrange for interpretation and there is no restriction in room assignment.)
- 3) The number of the sessions with simultaneous interpretation will be limited. Applications will be accepted in order of receipt. Please apply at your earliest convenience.
- 4) Although the organizer will arrange for interpreters of the highest possible grade, please note that the organizers do NOT assure the quality of interpretation. Exhibitors are expected to contact and discuss requirements with the interpreter agent to prepare for their presentations. Exhibitors are responsible for arranging their own consecutive interpretation.

#### **4. Cancellation of presentation or change of topic after manuscript submission**

When exhibitor would like to cancel the presentation or change the topic from the submitted manuscript due to unforeseen reasons, please assign staff members at the reception of the venue to notify the attendees of the cancellation or change of topic. Please note that the entry fee is NOT refundable. It is also the responsibility of the presenting company to staff the presentation reception desk and inform attendees of presentation cancellation or change of topic.

#### **5. Photographing, video and audio recordings and their public releases**

##### (1) Photographing, video and audio recordings

Please, apply for a “Company Booth Photo / Video Permit” in advance for taking photographs and/or videos, audio recordings of your own performances. These activities are permitted only for your internal use and are not for publishing.

Recordings of other exhibitors’ activities or shooting images in any forms are strictly prohibited.

##### (2) Public Release of the video recordings

Public release of the recordings taken at JASIS 2019 is prohibited.

##### (3) Public Release of the images

Please, give a credit to “JASIS 2019” when you release images taken at JASIS 2019 to the public.

Please, respect each individual’s legal or portrait rights when you take photographs. Releasing the images is totally exhibitors’ own risks. JASIS takes NO responsibility for any actions caused.

#### **6. Other Restricted Actions**

- 1) The providing of commemorative souvenirs or serving of drinks or foods to attendees is strictly prohibited. Should such activities be observed on the day of the presentation, our staff can end the activities promptly. However, exchange tickets for claim free gifts and technical materials may be distributed at your presentation venue if they are being used to promote exhibition attendance.
- 2) Problems have occurred in the past with being unable to start a presentation at the prescribed time due to mismatches between the PC used to prepare presentation materials and the PC brought to the presentation. Please prepare your files so that they can be handled by the PC you bring to the presentation.
- 3) The bringing in of hazardous substances, such as pressurized, flammable or toxic gases, chemicals with strong odors, and Class 4 hazardous substances (see page 25), is prohibited.
- 4) Explanatory equipment (excepting hazardous objects), LCD projectors, video cameras, and other devices may be brought into the venue.
- 5) Please refrain from loud noises that may be audible in neighboring rooms.

# Exhibit Guidelines

## 1. Installation and Dismantling (I&D)

Please read and understand the following instructions and make sure not to obstruct other exhibitors while **transporting and uncrating items during I&D**.

**The exhibitor's person in charge must be present during I&D.**

### (1) I&D time frame:

Referring to the overall timetable on page 5, please complete I&D within the time frame below.

#### 1) Move-in (Installation):

September 2 (Mon.) 8:00 AM to 5:00 PM, (Decoration materials) / 10:00 AM to 5:00 PM, (Exhibits)  
September 3 (Tue.) 8:00 AM to 3:00 PM, (All items)

#### 2) Move-out (dismantling):

September 6 (Fri.) 5:00 PM to 12:00 midnight,

Please finish moving everything, including decoration materials, out during the time frame above. For safety during removal of items, a timetable with staggered times, depending on the type of work, has been setup. Exhibitors are responsible for informing their removal personnel (moving and decoration contractors) of these requirements.

**17:00 to 17:30, removing the exhibits and panels (dismantling is prohibited)**

**(Shutters at north & south shall be half opened at 17:05, no vehicle entry.)**

**17:30 to 24:00 dismantling all structures and move out,**

**(Power supply shall be cut off at 17:30 and shutters shall be fully opened around 18:15 to allow vehicle access to floor.)**

### (2) I&D by vehicle:

- 1) Use South Gate 2 to enter the hall. Vehicles must leave the hall immediately after loading or unloading.
- 2) Security guards will be stationed at South Gate 2. The I&D Vehicle Registration (sticker), to be sent at a later date, must be shown on the vehicle's windshield. (This rule also applies to decorator vehicles.) Vehicles without a sticker may be refused entry to the hall.
- 3) If the hall is congested, special parking area (Block L) will be used as a waiting area. Please follow the instructions given by the security guard who will guide the vehicles in the area.

### (3) I&D vehicle routing:

Vehicles for the JASIS are to enter from South Gate 2 and exit from North Gate.

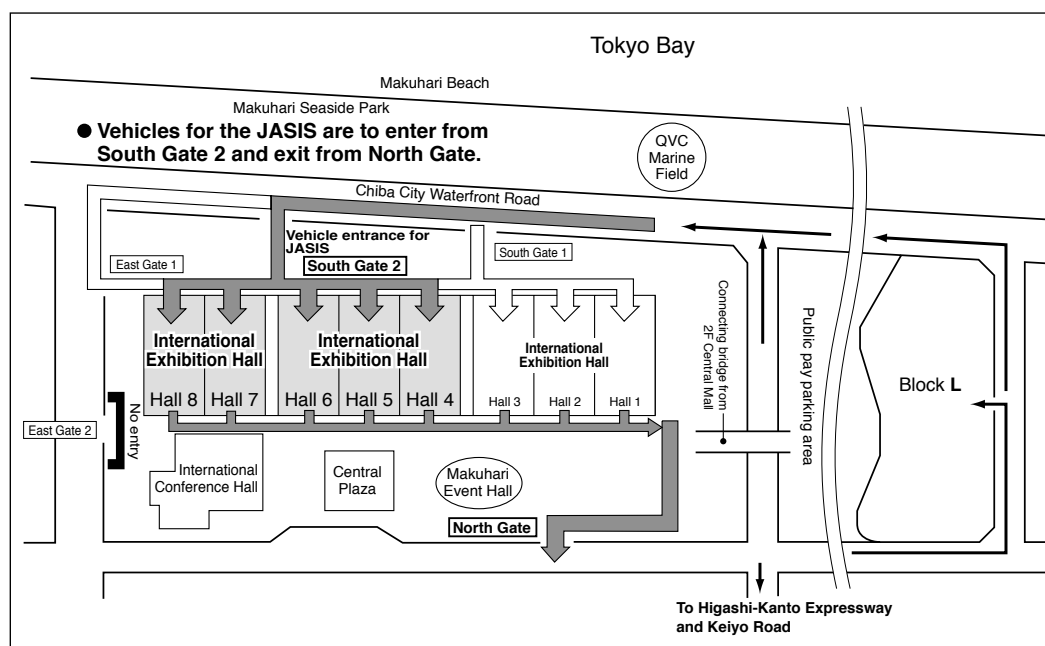

**(4) Delivery of exhibits to booth using parcel delivery service**

The destination label must show the exhibition name (JASIS 2019), hall #, booth #, and exhibitor name, receiving person and his/her mobile phone number, and designated delivery time (during working hours) so that the package can be properly received. Please note that the show office can NOT receive or store the package at any time.

<Marking Example>

JASIS 2019 Makuhari Messe Nakano 2-1, Mihama-ku Chiba-city Chiba Pref. 261-8550 Japan Hall Number : Booth Number : Exhibitor : Contact person :
--

**(5) Installation and Dismantling during show**

As a rule, during show installation and dismantling are prohibited. If this is unavoidable, report to the JASIS organizers before doing so.

**(6) Exhibitors' entering the venue during show dates**

From this year, exhibitor / contractor badges shall be swiped upon all entry.

September 4 (Wed.): from 8:00 AM

September 5 (Thu.) : from 8:30 AM

September 6 (Fri.) : from 8:30 AM

**(7) Wastes:**

Make sure to remove all waste materials including packing materials.

**(8) Others:**

The following drayage contractor is available to provide services with a fee. Please contact them directly. (Form 11)

<b>Cap Co., Ltd.</b> (contact person: Ohkawara) 4-25-18 Higashi-Shinkoiwa, Katsushika-ku, Tokyo 124-0023 Phone: +81-3-3695-0623 Fax: +81-3-3695-3088 Email: ookawara@cap1236.co.jp
---

## 2. Exhibition and Decoration

### (1) Stock space

The organizers will not provide stock space for exhibitors. If necessary, please take such measures as providing space in your own booths.

### (2) Booth locations

Booth locations (Less than 3 booths) will be decided by the JASIS Organizing Committee in the beginning of July, at which time exhibitors will be informed by e-mail.

### (3) Booth specification

**Basic Booth** (For \*other booth types please refer the [Application outline].

\*Other booth types : Life Science Innovation Zone / Mini / Solution Exhibition Area, Mini / Solution Catalogue Area / Research Organization Area / Academic Association Area / International Organization Area / Media & Press Area)

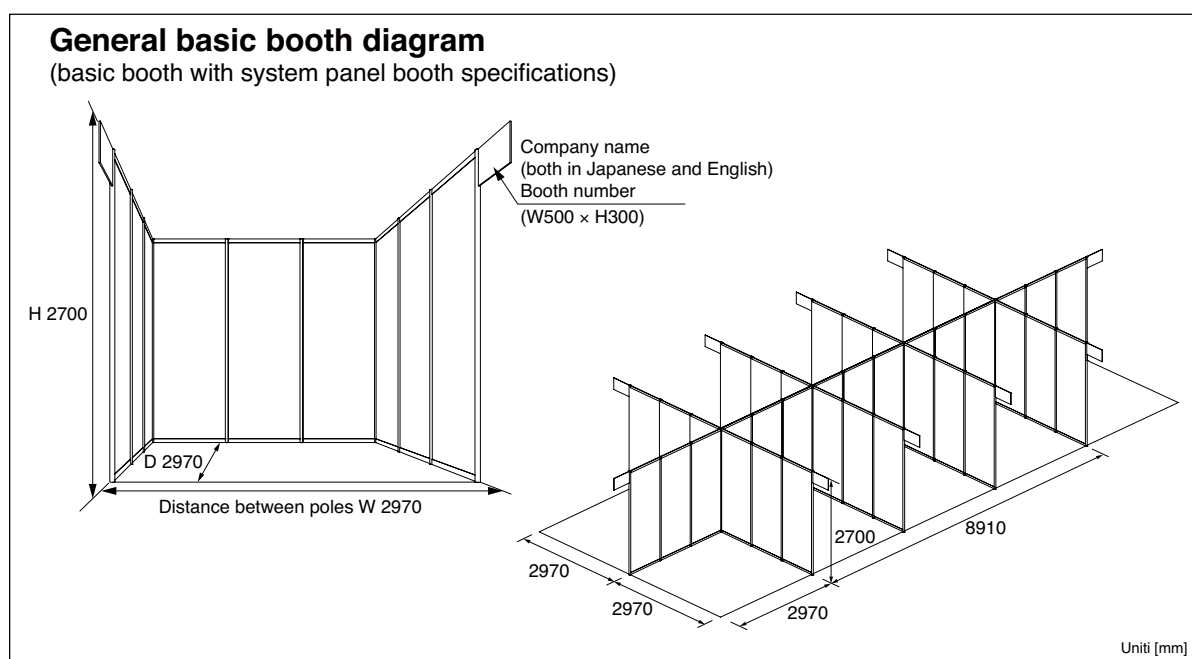

A) Distance between poles: 2.97 m (frontage) × 2.97 m (depth) × 2.7 m (height)

Note: The size of the general basic booth is different from the conventional wooden-panel booth. Please consider this in your construction.

Note: For height regulations on booth decorations, please check page 19.

B) All basic booths are constructed according to system panel booth specifications.

Note: The basic booth with system panel booth specifications is assembled from poles, beams, and white panel boards (vinyl-coated plywood).

(Please check the above diagram and page 17(5).)

C) Attachments are as follows:

- Back walls and sidewalls constructed as partitions

Note: Sidewalls on the passage side are not constructed on corner booths. Walls or decorations serving as walls may not be constructed in the setback space. See page 19 for definitions of walls and decorations serving as walls.

- Company nameplate protruding from both sidewalls (one place only for corner booths)

The company name and booth number will be shown in black on a styrene board (white) 500 mm wide and 300 mm high (both in Japanese and English).



D) The basic booth does not include carpets, parapets, lighting, outlets, exhibit stands, *etc.*

(Please see the diagram on the previous page.)

- Package booth and optional equipment

Please see the pamphlet “Package booth and optional equipment”.

You can also find related information on the JASIS websites.

Application deadline: June 28 (Fri.)

E) You can freely decorate within your booth.

For more details, please see the following.

- When you decorate your booth, please observe the restrictions described in article (5) Booth Decoration and (6) Construction Reminders on pages 16 to 22.
- For electrical work and power supply, please see pages 23 to 24, “3 Electricity, (3) Electricity installation costs and (4) Electricity charges”.
- Special decoration requirements in the booth: TEN Corporation (see below) is available for such work orders. Please consult TEN Corporation directly.

## 2) Independent Booth

Booth space exceeding 24 blocks (multiples of 8 booth blocks) is prepared as open space. (There will be no attachments.)

## 3) Construction

A) All basic booth partition walls (except for independent booths and booths larger than 16 blocks) will be constructed under the management of the Secretariat. (Decorations inside the booth partitions may be arranged by the exhibitor.)

B) Construction for independent booths and booths larger than 16 blocks must be arranged by the exhibitor.

C) The construction of basic booth partition walls shall be performed by the company below, under the direction of the Secretariat:

**TEN Corporation** (Contact Person: Kamisaka)  
1-5-9 Kotobuki, Taito-ku, Tokyo 111-0042 Japan  
Fax: +81-3-3842-7720 Email: [jasis@teninc.co.jp](mailto:jasis@teninc.co.jp)

**In case of infringement on the following restrictions and regulations, the organizing committee may order changes made. Booth space decoration regulations are quite different depending on whether you apply for an Independent Booth or a General Booth. Please ascertain the relevant regulations for booth design, decoration and display for the type of booth applied for. If you use a booth design company please ensure they are aware of the differences in regulations. Booth design companies should check with the exhibitor if it is unclear which booth design was applied for.**

## (4) Booth Decoration

Booth decorations must conform to the construction reminders, restrictions and rules. The contractors and the exhibitors together are to be fully responsible for any decorations inside the booth.

### 1) Registration of decoration contractors:

Booth decorators must register with the Secretariat by **July 1 (Mon.)** using attached form 1 “Decorator Registration Form”.

### 2) Construction and dismantling dates:

The construction of decorations must be conducted according to the Overall Timetable (See page 5), and the work must be completed by **5:00 PM on September 3 (Tue.)**. The dismantling of the decorations must **begin after 5:00 PM on September 6 (Fri.) and be completed by 12:00 midnight**. Please note that dismantling of structures and removal of lighting equipment must be carried out after 5:30 PM (See page 13).

### 3) Disposal of waste materials:

Please be sure to remove all wastes and residual materials generated by construction and dismantling.

## (5) Construction Reminders

### 1) Reminders specific to system panel booths

- A) The wall surfaces are not entirely flat. The metallic poles are installed on the wall surfaces of the panels at about 1m intervals, so convex surfaces of approximately the size of 10~20mm are formed on the surfaces.
- B) The basic system panels consist of vinyl-coated plywood. Therefore, they should not be decorated nor fabricated on.
- C) System panel components (panel boards, poles and beams, *etc.*) cannot be cut, nailed or drilled.
- D) The use of pins, thumbtacks and double-sided tapes with strong adhesives is not permitted on system panels. (If you use cellophane tapes or other materials, make sure to remove those during dismantling.

THE SYSTEM PANELS MUST BE RESTORED TO THEIR ORIGINAL CONDITION.)

- E) Use S-hooks or Velcro tape to display panels and other materials.

### 2) Parapet display

Only the names of registered companies can be shown on the parapet.

### 3) Prohibition of carpeting passages

No exhibitors are permitted to use their own carpet in public passages that lie between the sections of their booths.

- 4) **When installing doors** that open onto walkways, these doors should be hinged to open inward, or be slide style / accordion style doors. (Please refer to 8) of p.18)

- 5) If you must arrange exhibit objects along or close to the aisle, make sure maintaining smooth traffic flows. Visitors or a booth personnel shall not block the passage by staying on the aisle.

- 6) **Construction of ceiling or two-floor structures** (including the cloth covering at the upper part of the booth)

Exhibitors may construct these structures, based on prior notification and permission. Even when this construction is compliant with local fire regulations, exhibitors are requested to submit the application form to the Secretariat in advance, according to the procedure below.

- A) Please submit the notification document ("Application for Special Construction: Form 2") to TEN Corporation by July 1 (Mon.) via FAX.
- B) Also, please submit the necessary documents, described in a) and b) below, to TEN Corporation by July 30 (Tue.). The organizers need to consult with Makuhari Messe, and apply to and get approval from the local fire department.
- C) The organizers (secretariat) will provide notification of necessary information to exhibitors, including instructions and guidance from the fire department. Please be sure to observe them.
- D) The organizers will provide advance notification for booths deemed subject to fire inspection scheduled for September 3 (Tue.). In such cases, please do not leave the venue before inspection. (The inspection schedule is subject to change.)

### < Necessary documents and reminders >

- A) Construction of ceiling structures (including the cloth covering the upper part of the booth)  
Exhibitors who are planning this type of construction must submit a copy of diagrams to TEN Corporation by July 30 (Tue.), which show the construction place and the area size.

Note: **Owing to fire regulations, you are, for example, basically prohibited from constructing a stockroom or a dome-shape hanging in a presentation place with an enclosed structure. However, it may be possible to do this type of construction under instructions from the fire department if you notify and get approval in advance. If you are permitted, carry out this type of construction by observing the instructions.**

Permitted exhibitors must place a fire extinguisher in a place where it can be easily found and taken out. Also, depending on the construction, it may be necessary to provide a smoke detector.

**B) Construction of two-floor structure**

Construction of a two-floor structure will require an application stating measures taken for accidents, danger, and fire prevention. Exhibitors planning this type of construction are required to submit a copy of document materials to TEN Corporation by July 30 (Tue.), which include drawings (plane view and elevated view) and documents explaining the purpose of constructing the two-floor structure, construction materials, and the evacuation method in case of emergency.

Note: If an accident occurs resulting from the two-floor structure during the construction, during the show or after the show, the exhibitor who constructed this structure will bear full responsibility.

**[Definition of two-floor structure] (According to Makuhari Messe's Disaster Prevention Guideline)**

We define a two-floor structure as any multi-layered structure with a floor height of 2.1 m or more. However, even when the height of the highest floor is lower than 2.1 m, if the first floor is used for passage for visitors, exhibition space, or a staff room, this structure is regarded as a two-floor structure.

**7) Prohibition of direct fabrication**

Direct fabrication on the venue building, such as drilling holes into or painting the sashes, floor, walls, columns and passages, and using glue, is prohibited. However, you may install hole anchors on the floor. (Refer to the regulations on pages 22.)

**8) Loading & Unloading by Vehicles**

When loading, unloading, and transporting heavy loads by tow trucks and other vehicles, make sure to lay protective boards on the floor. DO NOT place hydraulic outriggers directly on the floor.

**9) Decorating materials**

Only flameproof materials can be used to decorate your booth. The use of combustible and ignitable materials is not permitted.

**If your booth is found to be in violation of related fire regulations during inspections carried out by the fire department, you may be requested to remove the items or modify your booth.**

**Please take extra care when decorating your booth.**

- A) Solid boards, plywood, veneers and printed veneers must be flameproof (soak-treated), display a flameproof certification sticker required by Article 4 of the Fire Prevention Law Enforcement Rules by Ministry of General Affairs Order on the front, and have a 5-line marking on the back.
- B) All flammable decoration, including curtains, artificial plants, paper and other materials, must be flameproof using the same treatment as the materials in A). As a rule, on-site spraying will not be permitted.
- C) The use of petroleum products, such as Styrofoam and urethane, flammable chemical fibers, and Hong Kong flowers, that are not flameproof is prohibited.
- D) Curtains (including accordion curtains) and carpets in the booth must be flameproof. Display the flameproof certification sticker required by the Fire Prevention Law Enforcement Rules on a readily visible location.

**10) Height restrictions**

Exhibitors who would like to construct decorations higher than 2.7 m are required to submit the "Application for Special Construction (Form 2)" before July 1 (Mon.), and also submit 1 set of construction drawings before July 30 (Tue.) to TEN Corporation.

**A) General booths (Row, Block, Opposing rows)**

- The height of booth interior decoration is to be no higher than 3.6 m from the floor level (except for independent booths, see below). Please note that the area that may be constructed up to

this height is the area inside the exhibitor's own booth set back (70 cm) from the passage or an adjacent exhibitor's booth.

- In the area within 70 cm from the passage, walls or structures up to 1.2m height may be constructed, except the pillars for parapet. When the space used not for the visitors (*i.e.* storage space) is constructed, the height limitation shall be 2.7 m even within the set back area, providing it conforms to the opening (wall) regulations below. The width of such space shall be no wider than 1/3 of the booth length.
- The height limitation within the setback area facing the adjacent booth (not facing the passage) shall be 2.7 m.
- Construction of any wall structure on the passage side is prohibited.

Note: Wall refers any structure constructed within the setback area that provides obstruction higher than 1.2 m area, structures including boards, slits, grids, curtains or any other materials that block sight.

- If the height of decorations differs from the booths of other companies nearby and your company name/logo is to be displayed facing these booths you must consult with the other company. This is to promote communication between companies and avoid unwarranted trouble at the exhibition. If a company wishes to discuss such matters that information will be relayed to the other company via the coordinator.

#### B) Independent booths

When independent booths are located at the end row, seen from the front entrance of the venue, their height shall be no more than 6 m above floor level. However, when independent booths close to each other are located front and back in a row, the height of the front-side independent booth (at the second row from the end row) shall be no more than 5 m.

- As mentioned above, the area that may be constructed up to a height of 6 m or 5 m is the area inside an exhibitor's booth that is set back from the passage by 70 cm.
- The area within 70 cm from the passage and adjacent booth may be constructed up to a height of 2.7 m.
- Walls lower than 2.7 m may be constructed at the passage side of independent booths, provided that those walls observe Opening Requirements stated below.

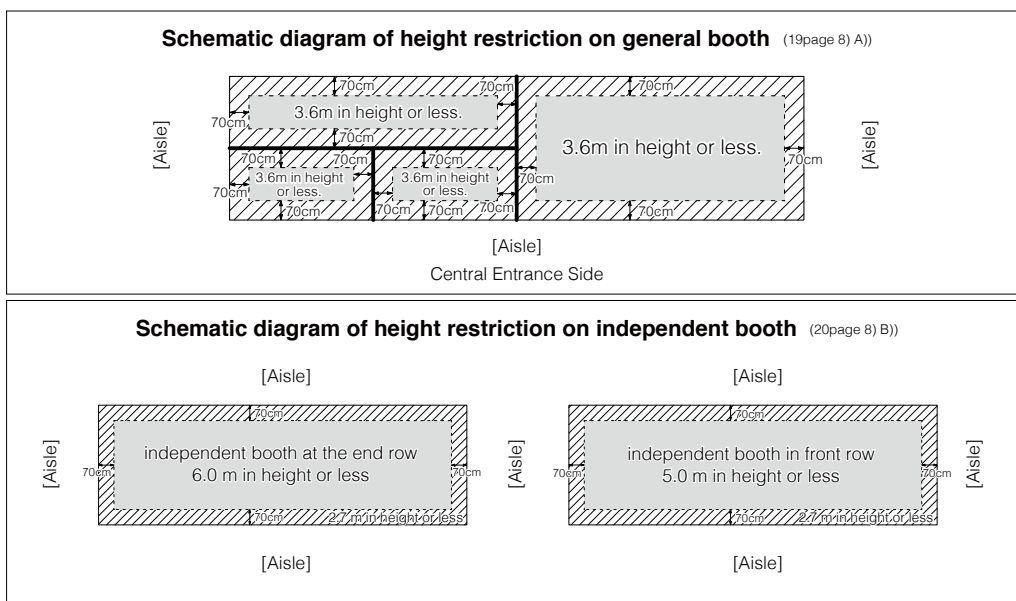

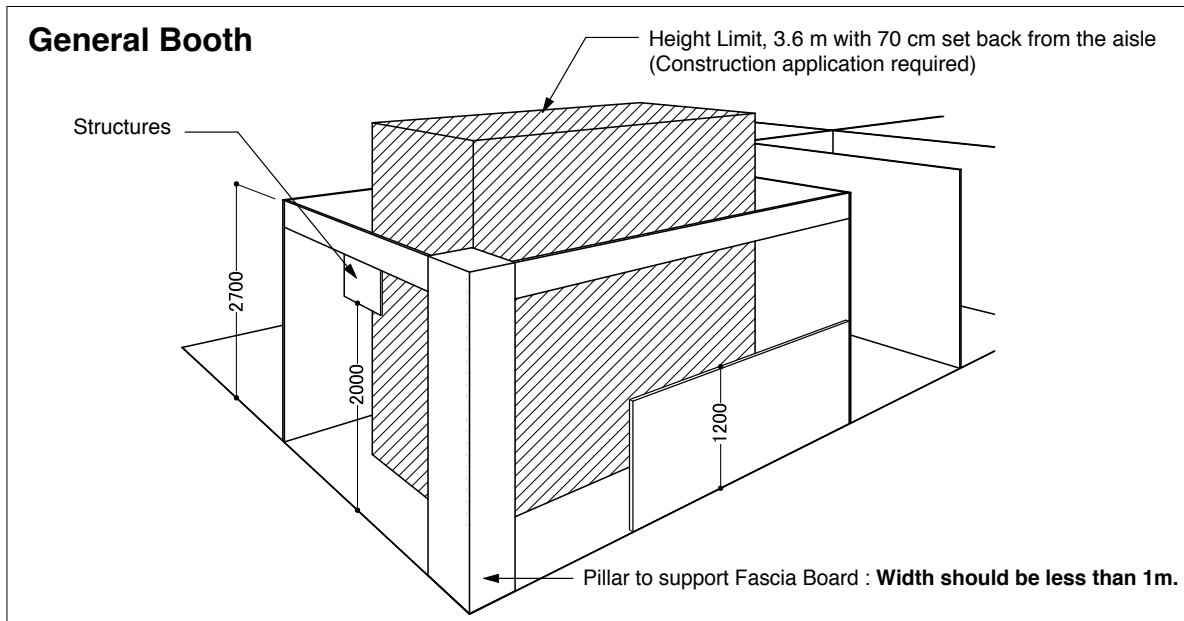

- C) Signs displaying company names and floating materials (balloons) are regarded as structures.
- D) There is no regulation for the height of exhibits. However, please notify the secretariat office when the height of such exhibits is higher than 3.6 m.

**11) Opening requirements at the passage side**

- A) For free flow of visitor traffic within the booth
  - a) General Booth (row, block, opposing row)

A continuous passage wider than 1.2 m is required. At least two openings are recommended for booths larger than 3 blocks.

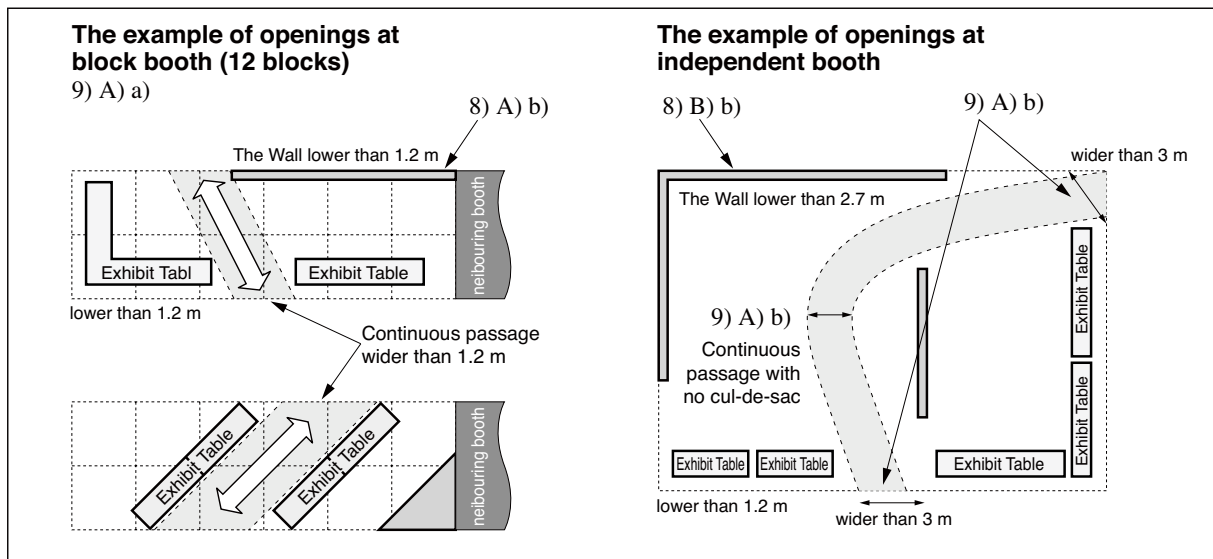

**b) Independent Booth**

Openings wider than 3 m are required on at least two different sides of the booth. There must be no cul-de-sac.

- B) For closed spaces within a booth

When constructing closed spaces (ex. meeting room, presentation space) within the booth, please secure exit(s) sufficient for all visitors' immediate evacuation in case of unexpected emergency. (At least two openings wider than 1.2 m are recommended.)

“Closed space” means areas for visitors surrounded by following objects:

- Wall surface
- Exhibition stand
- Reception stand
- Exhibition object
- Plant

**12) Regulations on presentations within the booth and noise prevention**

- A) When conducting presentations that involve a narrator with audio assistance from a monitor or screen, provide space for seating in accordance with the following figures. The distance between the monitor—measured at a right angle from the center of the face of the monitor—and the edge of the booth must be at least 5 m. The distance between the monitor's edges and the edges of the booth must be at least 1 m.
- B) When conducting presentations with sound effects from a monitor or screen without a narrator, provide space for seating in accordance with the following figures. The distance between the monitor—measured at a right angle from the center of the face of the monitor—and the edge of the booth must be at least 2 m. The distance between the monitor's edges and the edges of the booth must be at least 1 m.
- C) During the exhibit, do not create noise that will adversely affect other exhibitors. In particular, keep the volume of videos and microphones at a prudent level.
  - a) If external speakers are used, point these inwards. Never point them towards the passages. Please make sure not to disturb other exhibitors' activities.
  - b) When you place or embed speakers either on the floor or in a constructed structure, do not place them facing the passage. Adjust angle and position so that the speaker faces toward your booth. Please take into consideration your surroundings when installing speakers.

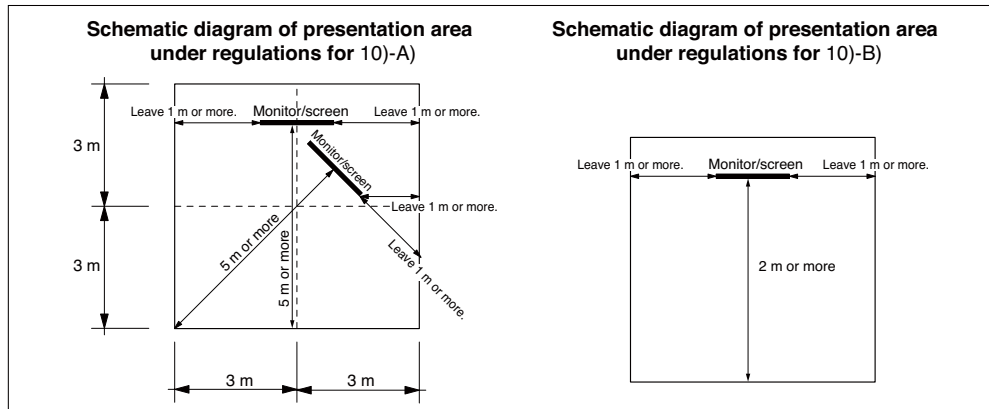

- D) During presentations by narrators (including employees of your company), passages may not be used as standing room for your audience. This is important for emergency safety and also to avoid inconveniencing other visitors. Make sure to design and construct your booth with sufficient space. In this case also, make sure that all speakers face toward your booth. Please observe regulations for speaker installation as stated in article C).

**For example, when ten chairs are provided, we anticipate that the number attending will not be more than 10. If there are more than 10, guide the attendees into your booth. If the Organizing Committee judges that participants standing in the passage are disturbing the free flow of visitor traffic, and that this situation did not improve even after an official warning, the Committee may suspend your presentation.**

- E) The sound level generated within a booth **must not exceed 70 dB when measured at 2 m from the front edge of the booth.**

**Summary of regulations on presentations**

Narrator	Sound	Monitor/screen	Distance opened to visitors within booth		Speaker
			From the front	From the edge	
○	○	○	more than 5 m	more than 1 m	Point it inside 70 dB or less
×	○	○	more than 2 m	more than 1 m	Point it inside 70 dB or less
×	×	○	Nothing	Nothing	—
×	○	×	—	—	Point it inside 70 dB or less

- F) Please refrain from facing the passage and loudly inviting visitors into your booths.
- G) In case of instruments demonstration, please take necessary measures to lower operation noise (bursting sounds, squeaking or high frequency noise—even if the noise level is within the limitation) to prevent disturbing other exhibitors.
- H) Presentations like below are prohibited
  - a) Making loud noises, using flashy lights, using smoke, to avoid misleading exhibitors into thinking an accident or a disaster is occurring.
  - b) Sounding bells or horns (except recorded music to be broadcast within the booth at a level lower than the 70 dB limitation.)
  - c) Projecting your company name, product name, or company sign (logo) onto a passage using a projector.
  - d) Using lighting equipment, such as laser light and/or flashing light, which might impair eyesight of other visitors.
- I) Please refrain from having demonstrators wear inappropriate clothing, which might reflect poorly on the JAIMA or JSIA.
- J) In cases of infringement, the Organizing Committee may order these activities to be suspended or changes be made.

### 13) Floor work

- A) The only permitted form of direct fabrication to the venue is the installation of hole anchors.
- B) If you plan to embed hole anchors in the floor of the venue, please observe the following instructions:
  - a) Submit the "Application for Special Construction (Form 2)" attached to the end of this brochure, by **July 1 (Mon.)** and a copy of your blueprint by **July 30 (Tue.)**, to TEN Corporation. They will file applications en bloc to Makuhari Messe, Inc. (Please note that, notwithstanding your filing of an application, some construction work might not be permitted for structural and other reasons.)
  - b) The illustration below shows the floor construction. The hole anchors must be no longer than 80 mm and no thicker than 12 mm, so that they will not disturb the PC floorboard.
  - c) Anchors are not to be embedded in the floor pit lid area or the point less than 200mm from pit.
  - d) If you fabricate the floor, you must restore the floor to its original condition immediately after the show. (See the illustration below.)
  - e) As a method of restoration, anchor bolts may be left in the floor by cutting the bolt head. All protrusions above the floor surface must be sanded down to the floor level. Do not hammer the anchors into the floor or use gas-arc cutting.
  - f) The Secretariat will send a bill to your company later, which charges a floor damage fee of ¥1,230 per anchor bolt.
  - g) Change after application for anchor bolt

If construction changes, such as floor construction, arise after submitting the application for special construction, please inform TEN Corporation of the changes by **August 23 (Fri.)**. If they are not informed, the bill shall be sent based on the original application. In addition, if changes of such as the number of anchor bolts and bolt positions arise after submitting the application for floor construction, please submit the application for the change as in the above cases.

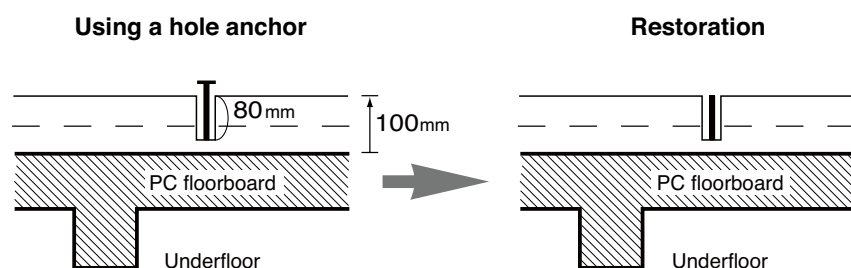

### 3. Electricity

---

#### (1) Applying for power Supply

Fill out the “Light and Power Installation Blueprint (Form 3)” attached to the end of this brochure, and submit it to the Secretariat by July 1 (Mon.). A licensed electrical work personnel or a contractor appointed by an exhibitor shall fill the mandatory Form 3, Light and power Installation Blueprint.

Note: Electricity bill is issued post JASIS to whom requested electricity supply. The bill is calculated as electrical installation costs plus electricity charges.

#### (2) Power specifications

1) The following power specifications are available. Please specify the specifications you require in the “Light and Power Installation Blueprint”.

- A) AC 100 V, single-phase, 50 Hz
- B) AC 200 V, single-phase, 50 Hz
- C) AC 200 V, three-phase, 50 Hz

2) The Secretariat will provide wiring services up to the breakers in each of the booths.

#### (3) Electrical installation costs

Please, pay wiring installation charges billed by the secretariat post JASIS 2019.

These charges are generated by the following formula: Unit price (JPY9,720 - inclusive of 8% consumption tax) times your total installed capacity (kW).

Your installed capacity for the calculation is determined by the total capacity shown in your Light and Power Installation blueprint. Fluorescent lamps and high-voltage mercury-arc lamps must be calculated at 1.5 times their rated capacity. Also, we roundup less than 1 kW capacity to 1kW.

Note: Electrical wirings inside your booth such as placing outlets will be separately billed by designated booth contractor.

#### (4) Electricity charges

Please, pay electricity charges billed by the secretariat post JASIS 2019.

Electricity charge is calculated with the following formula: Unit price (JPY2,052 - inclusive of 8% consumption tax) times your total installed capacity (kW) shown in your Light and Power Installation blueprint. Fluorescent lamps and high-voltage mercury-arc lamps must be calculated at 1.5 times their rated capacity. Also, we roundup less than 1 kW capacity to 1kW.

The above unit price is determined under the assumption that operation is eight hours a day for four days.

#### (5) Reminders regarding electric installation work within your booth

- 1) All personnel conducting the electric installation work must carry a license, such as the Electric Work Specialist License issued according to the Electric Work Specialist Law, while they work.
- 2) Electrical appliances subject to the Electrical Appliance and Material Control Law must display a label showing that the model has been certified by the Minister of Economy, Trade and Industry.
- 3) Heat generating equipment, such as incandescent bulbs and resistors, must be installed in such a way that they do not make contact to flammable materials or people, or become overheated.  
The use of neon lights is prohibited.
- 4) Distribution panels and other regulating equipment must be contained in steel or plastic boxes (model certified) and must be installed in a place where they are easy to service and inspect. Please take extra care when installing these in the storage room. Always include the name of the installer and their phone number on the distribution panel.
- 5) Do not use vinyl cords to wire lighting and other equipment. Always use cables with the same capacity as an F cable with a thickness of 1.6 mm or greater. Use appropriate electrical materials such as crimp terminals for connecting wires.
- 6) If you want to run wires on the floors or passages in your booth, use saddle-fixed iron pipes, molding, iron cover plates and rubber mats so that they do not obstruct pedestrian traffic.



- 7) For branching switches in the booth for general purposes: Use breakers or cover switches that meet the capacity of your equipment. Cover switches must be equipped with an appropriate fuse. Never use copper wire or similar objects as a substitute. Do not overload the wirings from the switch.
  - 8) When using electricity near water (for equipment that uses both water and electricity, for example), equip the main switch at the distribution panel or the branch switches with a leakage breaker that meets the capacity of your equipment.
  - 9) Wiring for lighting outlets must be equipped with one branch switch for each piece of equipment with a capacity of 15 A or greater. Otherwise, group your equipment for a total of 15 A or less into single circuits and use a branch switch for each circuit.
  - 10) Equipment with a voltage to ground of 150 V or greater must be securely grounded. (If your distribution panel is enclosed in a steel box, always ground the casing.)
  - 11) During construction, take special care to prevent electrical accidents including fires, personal injury and property damage. No construction work shall be permitted under any circumstances once the show has started, so make sure to complete your construction before the show starts.
- (6) Hours of power supply to your booth**
- 1) Power will be supplied from 9:00 AM on September 3 (Tue.) to 5:30 PM on September 6 (Fri.).
  - 2) Exhibitors who need an alternative arrangement, please inform Ten corporation in advance.
- (7) 24-hour power supply**
- If your exhibit requires a 24-hour power supply, make sure to indicate this in your “Light and Power Installation Blueprint” (Form 3) using red ink. Also make sure that the electric installation contractor for your booth and the power mains installer go over the details before the installation.
- (8) Others**
- 1) An electrical maintenance attendant will be stationed at the Secretariat Office during the show. Please contact the Secretariat as soon as possible in the event of an electrical accident in your booth.
  - 2) JASIS organizers have the right to exercise electrical inspections in any exhibit booth if necessary.
  - 3) The power mains installation work will be performed by the following company.  
Please contact their office for questions regarding the power mains installation.

<p><b>Iida Electrical Works Co., Ltd.</b> (contact persons: Mr. Nakamura) 1-8-21 Shinkiba, Koto-ku, Tokyo 136-0082 Phone: +81-3-3521-3522 Fax: +81-3-3521-3524 Email: jasis@iidae.co.jp</p>
---

## 4. Fire Safety

The Fire Service Act generally prohibits smoking and the use of open flames in the venue, as well as carrying in of hazardous substances. However, if such activities or substances are essential to your exhibit, the Secretariat will file an “Application for Authorized Cancellation of Prohibited Activities” with the fire department, which may allow you to perform such activities or use such substances.

Exhibitors whose structures are subjected to fire inspection and who have provided notification of hazardous materials are requested to have their person in charge attend fire inspection, scheduled for the day before opening of the show from 15:00. Please do not leave the venue before inspection.

From the fire safety standpoint, observe the following rules regarding smoking and the use of open flames in the hall, and the carrying in of hazardous substances.

### (1) Fire Inspection

Fire inspection is required on the day before the opening of the show. Exhibitors will be notified of the date and time by the secretariat when decided. It is possible that the inspection time will be after 17:00. If inspection is not properly completed, not only will exhibition by the exhibitor in question not be allowed, but the JASIS itself may be subject to cancellation. Do not fail to undergo inspection.

### (2) No smoking policy

Please make sure that this non-smoking policy is fully understood by everyone who enters the venue including drayage contractors and decorators.

1) In booths and in Halls 4, 5, 6, 7 and 8: Smoking is prohibited at all times (including during such operations as carrying in, removal, decoration, and dismantling)

In particular, smoking in the corners, door side, and stair area of the halls during installation and dismantling by workers is often observed. It is the responsibility of each exhibitor to thoroughly inform workers of the no smoking policy in the control of installation and dismantling work.

2) Smoking is prohibited in interior common areas in Makuhari Messe (passageways, malls, lobbies, etc.). Smoking is allowed only in the designated area.

3) **Starting from installation to the end of dismantling, if someone is found smoking outside designated smoking areas, the smoker and the exhibitor management responsible should submit an official written apology to the Show Office.**

### (3) Use of open flames and hazardous substances

The following criteria must be met:

1) If you plan to use open flames or carry in any of the Class 4 hazardous substances listed below, submit the Application for the Use of Open Flames and Hazardous Substances (Form 5) attached to the end of this brochure to TEN Corporation by **July 1 (Mon.)**.

2) Exhibitors who have provided notification of hazardous substances are requested to contact the organizers, submit a form for cancelling of the bringing in of hazardous substances, and undergo fire inspection, where bringing in of have conselled.

3) For hazardous substances that you will be using for your demonstrations: Each day, carry in only the amount needed for that day.

4) Platforms and nearby areas where an open flame will be used must be covered with non-flammable materials other than metals.

5) The use of fire or sparks near the hazardous substances is prohibited.

6) Handle the container with care to prevent it from tipping over or the substance from leaking.

7) **Install a fire extinguisher (larger than grade 10) and mark its location clearly.**

#### Type of hazardous substance (Class 4)

- Special inflammable substances (ex. diethylether and carbon disulfide)
- Type 1 oils (ex. gasoline, thinner and acetone)
- Alcohols
- Type 2 oils (ex. kerosene and diesel oil)
- Type 3 oils (ex. grade-A heavy oil, mechanical oil and creosote oil)
- Type 4 oils (ex. spindle oil, gear oil, lubricants and hydraulic fluid)
- Animal and vegetable oils (ex. edible oils)

**Other fire hazards and hazardous substances:** spray oil, turpentine oil, benzol, chlor, concentrated sulphuric acid, nitrogen gas, argon gas, propane gas, Hydrogen gas, freon gas, carbon gas, other pressurized gasses, large amount of matches, celluloids, ammonia and washing liquids for machines.  
\*Liquid nitrogen stored in a designated container is exempted.

### (3) Other reminders

1) Fire extinguishers must be installed at easy-to-locate places near areas where their installation is mandated, including the areas where hazardous substances will be used.

2) When bringing in air tanks, etc. into the venue, the contents of the tank must be clearly marked on the outside (and fastened securely so that the tag does not fall off) regardless of the contents. If the tank contains a hazardous substance you must fill out Form 5.

3) Prior to the opening of the show, protective plastic tarps used on the carpets during installation must be removed from all areas including from underneath the exhibit platforms and inside the storage room.

## 5. Phone, Internet

Exhibitors requiring phone and internet lines in their booths should apply to Kissei Comtec Co., Ltd.

### (1) Application

Apply to Kissei Comtec Co., Ltd. using attached form 10, "Application for Temporary Phone, ADSL, ISDN and Optical Fiber connection" by July 26 (Fri.).

### (2) Charges

Installation will start after verification of remittance of funds. An invoice will be issued after receipt of application. Please complete remittance by August 16 (Fri.).

Line	Charge	Remarks
Temporary Phone	¥17,500	※Includes ¥2,000 of call charges. ※Excess call charges will be invoiced separately.
Optical Fiber	¥86,400	※Includes router and provider (variable IP).

- The above installation charges will not change even if you provide your own equipment and devices.
- Phone includes ¥2,000 of call charges. Excess call charges will be invoiced separately.
- Line speed cannot be guaranteed. Any communication fault can NOT be compensated.
- IP addresses are automatically acquired by the router.
- LAN cables are not included. Exhibitors should provide their own cables for connecting router to PC.
- Please provide a separate HUB when connect 5 or more PCs.
- When a fixed IP is required ¥16,800 for one fiber optics fixed IP will be incurred. If more are required, please contact below Kissei Comtec contacts.
- OP25B (Outbound Port 25 Blocking) is set by the provider to prevent SPAM. Sending of Email using port 25 is therefore not possible. Please use port 587 or VPN for sending of email. (However, this does not apply to exhibitors who have applied for a global IP option.)
- For your own Wi-Fi set-up and its fees, please inquire to below Kissei Comtec contacts.

Exhibitors are requested to be sure to perform Windows updates, anti-virus measures, and anti-information leakage measures. JASIS and Kissei Comtec will not bear any responsibility for related problems.

### (3) Notification of phone number

The exhibitors' contact person for the JASIS will be informed of the assigned phone number ten days to two weeks ahead of the show. JASIS and Kissei Comtec shall not be responsible for any communication failure caused by service providers.

### (4) Others

Do not apply at the telephone company directly as this will cause unnecessary confusion.

Installation will start after verification of remittance of funds. An invoice will be issued after receipt of application. Please complete remittance by August 16 (Fri.).

**Kissei Comtec Co., Ltd.** (Contact person: Mr. Toda, Mr. Akiyama)  
TEL: +81-3-6709-2440 FAX: +81-3-5979-6335  
E-mail: jasis@network.kcrent.jp

## 6. Water Supply, Drainage and Compressed Air

When an exhibitor requires a water supply, make sure to file an “Application for Water supply, Drainage, Compressed Air” (form 6) no later than July 1 (Mon.) to TEN Corporation.

Organizer will examine the contents of exhibitors’ presentations at the booths and may instruct or order the change or halt the presentations if regulation violation was found.

- During the exposition organizer staff shall be at the site. Please notify any accident immediately to the secretariat office.
- Piping work of water drainage and compressed air to the booth shall be conducted by the organizer. Piping work of town gas shall be conducted by the designated contractor for safety reason.
- The charge for primary connection work shall be invoiced to the exhibitors after the show.

The piping work of water, drainage and compressed air should be arranged by the exhibitors.

Water, air and gas supply shall be from 16:00 to 18:00 on September 3 (Tue.) and 8:30 to 17:30 from September 4 (Wed.) through 6 (Fri.). Additional charges may apply for the overtime supply, please consult the contractor.

### (1) Water supply and Drainage

Please indicate the required size and position of pipe outlet and usage per hour in your application form.

Water supply piping:

from 13 mm to 20 mm ø(diameter) ¥75,000 (primary piping, maintenance included)

25 mm ø(diameter) ¥80,000 (primary piping, maintenance included)

The charge for water is ¥821 / 1 m<sup>3</sup>, calculated based on the meter reading and invoiced to the exhibitors after the show.

### (2) Compressed Air

The supply pressure shall be 600 kPa minimum (Please attach regulator at your booth and regulate the pressure below 600 kPa.) and flow rate shall be below 300 L per min. (If you require more than 300 L per min. please consult contractor.)

The fee shall vary according to the number of applications and flow requirement and shall be quoted separately.

The surcharge of ¥2500 / hr. (before 8:30) and ¥5000 / hr. (after 18:00) shall be added for the overtime air supply.

### (3) Town Gas

The gas supply is limited to Town gas only.

- 1) To use town gas at your booth, the “Application for the Use of Open Flames and Hazardous Substances” (form 5) shall be submitted and the permit is required.
- 2) Please submit the brochure copies of the instruments using town gas to register the gas demands at your booth.

### (4) Notes

Please do not drain any water or wastes to the pit of exhibition floor, since the electrical wires and gas, air piping are installed in the pit.

Primary work designated contractor for water supply and drainage, compressed air, and gas work (secondary work designated contractor for gas work)

**Yamazaki Kogyosho Co., Ltd.** (Contact: Mr. Katsuya / Mr. Hattori)  
4-23-17 Honcho, Nakano-ku, Tokyo 164-0012, Japan  
Phone: +81-3-3383-3541 Fax: +81-3-3380-1298  
E-mail: katsuya@kk-yama.com

## 7. Rental Meeting Rooms and Lounges

The meeting rooms on the first level and guest lounges on the second level at the north side of the exhibition halls are available for rent. The order shall be served in order of arrival.

- Applicants: Limited to the exhibitors of JASIS 2017. (Meeting room rental is limited to General exhibitors only.)
- Application: Fill out the Form 4 in this manual to apply.
- Usage: Meeting, Business, Storage and Waiting room. (Exhibition or seminar is prohibited.)
- Prohibited use: Use for exhibition and seminars is prohibited.

### (1) Meeting Rooms on the first level of exhibition halls

- Dates: From September 3 through September 6, Four days (9:00 ~ 17:00)  
\* Daily rental is not available.
- Rooms, Furnitures and Fees

\* Please contact TEN Corporation if you need extra options of facilities(charged).

Rental hall	Floor area	Facilities		4-day charge (inclusive of tax)
		Conference tables (pcs.)	Folding chairs (pcs.)	
Hall 4, West (1 Room)	80 m <sup>2</sup>	10	30	¥ 259,200
Hall 4, East (1 Room)	112 m <sup>2</sup>	10	30	¥ 304,560
Hall 5, West (1 Room)	112 m <sup>2</sup>	10	30	¥ 304,560
Hall 5, East (1 Room)	112 m <sup>2</sup>	14	42	¥ 304,560
Hall 6, West (1 Room)	80 m <sup>2</sup>	10	30	¥ 259,200
Hall 7, West (1 Room)	112 m <sup>2</sup>	10	30	¥ 304,560
Hall 7, East (1 Room)	80 m <sup>2</sup>	10	30	¥ 259,200
Hall 8, West (1 Room)	112 m <sup>2</sup>	14	42	¥ 304,560

### (2) Guest Lounges on the second level of exhibition halls

(Total 3 rooms each in halls 4, 6, and 8)

- Dates: From September 4 through September 6, 10:00 - 17:00 (Hourly rental available)  
\* The lounge at hall 6 starts at 11:00 on September 4.  
\* Minimum rental hour is 1 hour.
- Fee: (one room) ¥20,520 / hour (¥54,000 for 1 day)  
\* Blind panel(s) may be arranged with additional fee.
- Specifications: Floor area 57.6 m<sup>2</sup> (W 12 m x D 4.8 m)  
Location: Photo 1 on the next page shows the space set off like a balcony from the venue. (Photo 2 shows the lounge from the hall.) This space is open towards the venue side (Photo 1, left side). It has no wall other than a fence of about 1 m height. Because noise enters directly from the venue, this space may be used as a place to receive guests or conduct business while experiencing the bustle of the show. If serving refreshments, please set up a screen panel (separate charge). The right of Photo 1 shows the building passageway that the space faces. It is separated by a glass wall, but will be provided with curtains (Photo 3) to partition the space from the passageway.
- Furnishings: 2 sets of sofas & table (for 8 people), refrigerator (with 12 bottles of tea and 12 bottles of mineral water)

Photo 1



Exhibition hall

Guest Lounge  
(2nd floor (north))

Cartain

Photo 2

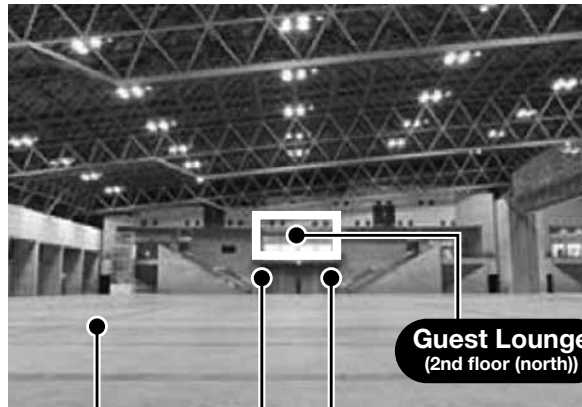

Guest Lounge  
(2nd floor (north))

Exhibition hall

Escalator

Photo 3



Lounge (Inside)

## 8. Servicing Foods or Beverages

- The serving of alcoholic beverages is restricted.
- When an exhibitor plans to serve foods and/or beverages to visitors, please consult the local Health Office indicated below. Please also submit a notification to the Show Office using attached Form 9. (Submission deadline : July 26 (Fri.)) However, if the exhibitor does not use an outside service contractor and there is no cooking, (ex. the serving of coffee using a coffee maker at the booth) notification is not necessary.

The Health Office may issue instructions for hygienic purposes, such as sterilization and/or water plumbing regulations. Non conformance to the instructions may be resulting in cancellation of foods service.

**Local Health Office:** Chiba City Health Office, Foods Safety Division  
 2nd Fl, Chiba General Health-Care and Clinical Center  
 1-3-9 Saiwai-cho Mihama-ku, Chiba 261-8755 Japan  
 Tel: +81-43-238-9934 (In Japan: 043-238-9934)

## ■ List of Forms, Applications and Submission Deadlines

Document to submit		Page of related items	Application deadline	Number of copies to be submitted	Where to submit
Form 1	<u>Decorator Registration Form</u>	13-22	Monday, July 1	1 copy (mandatory)	TEN Corporation
Form 2	Application for Special Construction 1) Decoration for higher than 2.7 m 2) Ceiling structure and 2 story structure 3) Anchor bolts	17-20 22	<Form> Monday, July 1 <Drawing> Tuesday, July 30	1 copy (with 1 copy of drawing)	
Form 3	<u>Light and Power Installation Blueprint</u>	23-24	Monday, July 1	1 copy (mandatory)	
Form 4	Application for Meeting Rooms and Guest Lounges Rental	28	Monday, July 1	1 copy (arrival in order)	JASIS 2019 Organizing Committee Att. Japan Analytical Instruments Manufacturers' Association
Form 5	Application for the Use of Open Flames and Hazardous Substances	25	Monday, July 1	1 copy	TEN Corporation
Form 6	Application for Water, Drainage, Compressed Air and Town Gas (Town gas application require form 4 also)	27	Monday, July 1	1 copy	
Form 7	Application for Change of Address or Number of Tags for Exhibitors	7	Friday, July 5	1 copy	JASIS 2019 Organizing Committee Att. Japan Analytical Instruments Manufacturers' Association
Form 8	Confirmation Request for Products Needing Application for Industrial Property Right	7	Friday, July 26	1 copy	
Form 9	Notification of Foods & Beverages Service	29	Friday, July 26	1 copy	
Form 10	Application for Temporary Phone, Internet	26	Friday, July 26	1 copy	Kissei Comtec Co., Ltd.
Form 11	Application for the Use of Drayage Machinery	14	Friday, July 26	1 copy	Cap Co., Ltd.
Form 12	Application for dispatch of translators and reception Staff		Friday, July 26	1 copy	GR Congress Co., Ltd.
Form 13	Visa Application		Friday, June 21	1 copy	JASIS 2019 Organizing Committee Att. Japan Analytical Instruments Manufacturers' Association
	Package Booth Display Order Form	On JASIS website, also sent to exhibitor via Email	Friday, June 28		Ten Corporation

- **Make sure that the documents are submitted by the deadlines stated above.**
- The forms listed above are attached to the end of this brochure.  
Please be sure to make a copy of these documents for your records.

**JASIS 2019**

# **Decorator Registration Form**

**Prior Notification of laying carpet in the passage between opposing booths (8 or more booths)**

---

Exhibitor name: \_\_\_\_\_ Booth No. \_\_\_\_\_

Address: \_\_\_\_\_ Phone: \_\_\_\_\_

\_\_\_\_\_ Fax: \_\_\_\_\_

Section \_\_\_\_\_ Name: \_\_\_\_\_

**Deadline: Submit one copy by Monday, July 1.**

**Submit to: TEN Corporation**

Via Fax: +81-3-3842-7720 or Email: [jasis@teninc.co.jp](mailto:jasis@teninc.co.jp)

**Our decorator's information is as follows:**

Name of decorator	
Address	
Phone	
Fax	
Name	

- Move-in time:      ① 8:00 – 17:00, Monday, September 2  
                             ② 8:00 – 15:00, Tuesday September 3
- Move-out time:    17:00 – 24:00, Friday, September 6
- Vehicle entrance: South Gate 2
- Waste material:    Always take waste material and carpets out of the venue and dispose.



JASIS 2019

# Application for Special Construction

1) Decoration for height of 2.7 m or more    2) Ceiling or two-floor structures    3) Anchor bolts

Exhibitor name: _____	Booth No. _____
Address: _____	Phone: _____
_____	Fax: _____
Section _____	Name: _____

Billing address if different from above:

Company name: _____	Phone: _____
Address: _____	Fax: _____
Section: _____	Name: _____

**Deadline: Submit one copy by Monday, July 1.**

**Submit to: TEN Corporation**

Order by Fax: +81-3-3842-7720 or Email: jasis@teninc.co.jp

**We are applying to perform the following installation work:**

1) Decoration for height of 2.7 m or more      Yes    /    No      (Circle either.)					
2) Ceiling structures    /    Two-floor structures      (Circle either.) Planned to be constructed					
3) Floor work (insertion of anchor bolts)      Anchors must be no longer than 80 mm and no thicker than 12 mm.					
Details of work 3)		Number of locations	Number of anchors per location	Total number of anchors	Bolt thickness
		location(s)	anchor(s)	anchor(s)	mm
Installer	Company name				
	Address				Phone
					Fax
	Name				

- \* Submit 1 copy of blueprint in any case of 1) to 3), by Tuesday, July 30.
- \* Always observe the “Construction reminders” (pages 17 to 22), “Construction of ceiling or two-floor structures” (pages 17 and 18), and “Floor work” sections (Pages 22).
- \* If you add changes for 3), please inform TEN Corporation of the changes by August 23 (Fri.). If you do not, TEN Corporation will send a bill to you according to the above mentioned application.

**JASIS 2019**

# Light and Power Installation Blueprint

Exhibitor name: \_\_\_\_\_ Booth No. \_\_\_\_\_

Address: \_\_\_\_\_ Phone: \_\_\_\_\_

Fax: \_\_\_\_\_

Section \_\_\_\_\_ Name: \_\_\_\_\_

**Deadline: Submit one copy by Monday, July 1.**

**Submit to: TEN Corporation**

Order by Fax: +81-3-3842-7720 or Email: jasis@teninc.co.jp

Please have your contractor fill out this form. (When your contractor were not fixed, please consult IIDA Electrical Works Co., Ltd.)

Power mains installer:		Iida Electrical Works Co., Ltd.		1-8-21 Shinkiba, Koto-ku, Tokyo, 136-0082 Phone: (03)3521-3522 Fax: (03)3521-3524					
In-booth electrical installer		Name _____		Phone _____					
		Address _____		Fax _____					
Lighting 100 V	Appliance name & capacity	W	W	W	W			Total	Total capacity
	Quantity								
Power 200 V	Capacity	kW	kW	kW	kW			Total	Total capacity
	Quantity								

(Note) If you are using single-phase 200 V, indicate this clearly.

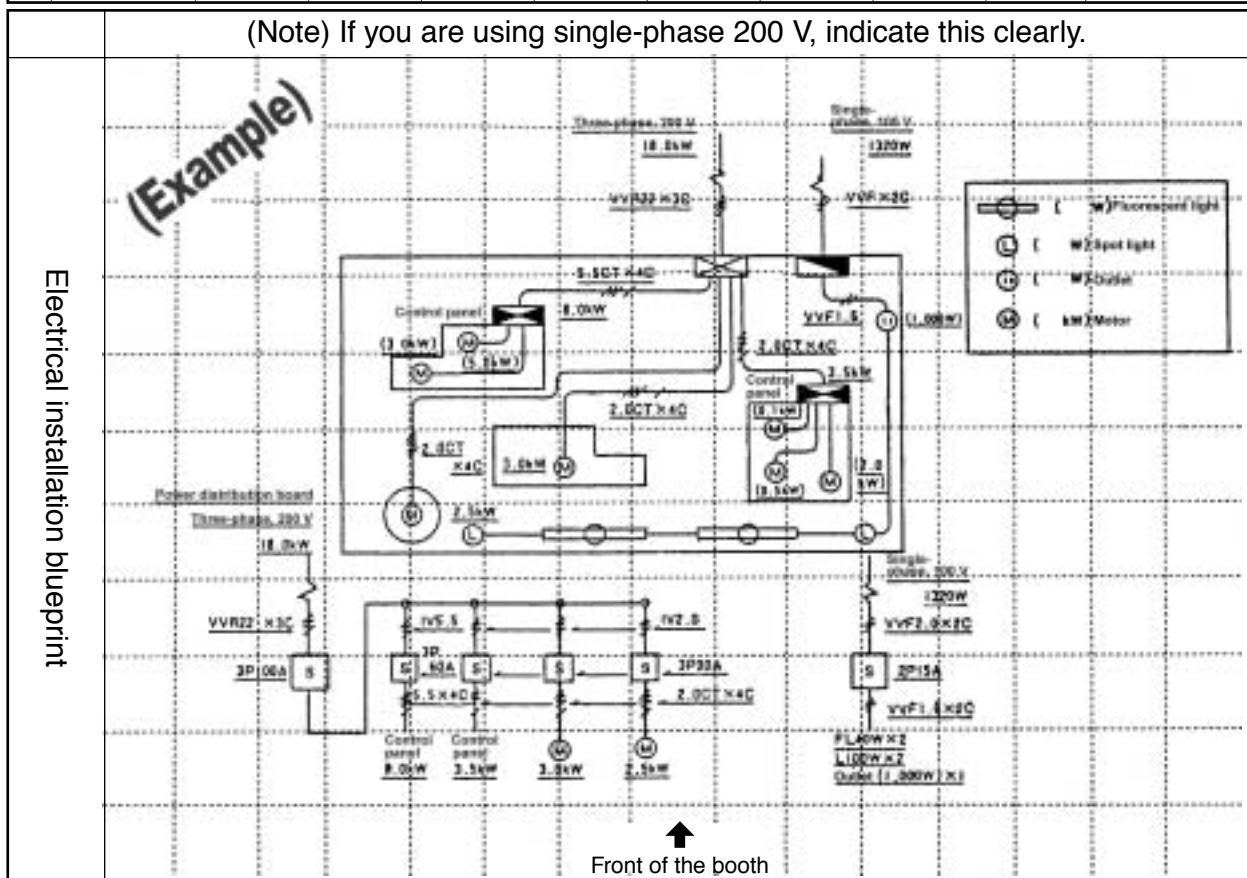

- Notes
1. Describe the wattage with an abbreviation of appliance. For example, FL 40 W indicates fluorescent lights of 40 W, and L 100 W indicates incandescent lights of 100 W, etc.
  2. Multiply the total capacity for fluorescent lamps and high-voltage mercury-arc lamps by 1.5.
  3. If you are unable to include the wiring and connection diagrams in this form, write "See attachment," and attach the diagrams on a separate sheet.
  4. If you require 24-hour power supply, indicate this in red ink.

# Light and Power Installation Blueprint

Exhibitor name: \_\_\_\_\_ Booth No. \_\_\_\_\_

Address: \_\_\_\_\_ Phone: \_\_\_\_\_

Fax: \_\_\_\_\_

Section \_\_\_\_\_ Name: \_\_\_\_\_

Billing address if different from above:

Company name:	Phone:
Address:	Fax:
Section:	Name:

**Deadline: Submit one copy by Monday, July 1.**

**Submit to: TEN Corporation**

Order by Fax: +81-3-3842-7720 Email: jasis@teninc.co.jp

Please have your contractor fill out this form. (When your contractor were not fixed, please consult IIDA Electrical Works Co., Ltd.)

Power mains installer:		Iida Electrical Works Co., Ltd.				1-8-21 Shinkiba, Koto-ku, Tokyo, 136-0082 Phone: (03)3521-3522 Fax: (03)3521-3524			
In-booth electrical installer		Name _____				Phone _____			
		Address _____				Fax _____			
Lighting 100 V	Appliance name & capacity	W	W	W	W			Total	Total capacity
	Quantity								
Power 200 V	Capacity	kW	kW	kW	kW			Total	Total capacity
	Quantity								

(Note) If you are using single-phase 200 V, indicate this clearly.

Electrical installation blueprint																				

↑  
Front of the booth

- Notes
1. Describe the wattage with an abbreviation of appliance. For example, FL 40 W indicates fluorescent lights of 40 W, and L 100 W indicates incandescent lights of 100 W, etc.
  2. Multiply the total capacity for fluorescent lamps and high-voltage mercury-arc lamps by 1.5.
  3. If you are unable to include the wiring and connection diagrams in this form, write "See attachment," and attach the diagrams on a separate sheet.
  4. If you require 24-hour power supply, indicate this in red ink.

# Application for Meeting Rooms and Guest Lounges rental

Exhibitor name: \_\_\_\_\_ Booth No. \_\_\_\_\_  
 Address: \_\_\_\_\_ Phone: \_\_\_\_\_  
 \_\_\_\_\_ Fax: \_\_\_\_\_  
 Section: \_\_\_\_\_ Name: \_\_\_\_\_

## Billing address if different from the above address:

Company name:	Name:
Section:	
Address:	
Phone:	Fax:

**Deadline: Submit one copy by Monday, July 1.**

**Submit to: JASIS Organizing Committee**

Att. Japan Analytical Instruments Manufacturers' Association  
 webmaster@jaima.or.jp (Fax: +81-3-3292-7157)

## We hereby apply for Meeting Room / Guest Lounge Rental

Meeting rooms	4 days rental fees (Electricity charge and Consumption tax included)	Circle your choice
Hall 4, West (1 Room)	¥259,200	
Hall 4, East (1 Room)	¥304,560	
Hall 5, West (1 Room)	¥304,560	
Hall 5, East (1 Room)	¥304,560	
Hall 6, East (1 Room)	¥259,200	
Hall 7, West (1 Room)	¥304,560	
Hall 7, East (1 Room)	¥259,200	
Hall 8, West (1 Room)	¥304,560	
Total      ¥		

Guest Lounge at	hourly use			day use	
	use date & time	fee (¥20,520 / hour) (Electricity charge and Consumption tax included)		use date	fee (¥54,000 / day) (Electricity charge and Consumption tax included)
hall 4	Sep. _____ : 00 – _____ : 00	¥		Sep. _____	¥
hall 4	Sep. _____ : 00 – _____ : 00	¥		Sep. _____	¥
hall 6	Sep. _____ : 00 – _____ : 00	¥		Sep. _____	¥
hall 6	Sep. _____ : 00 – _____ : 00	¥		Sep. _____	¥
hall 8	Sep. _____ : 00 – _____ : 00	¥		Sep. _____	¥
hall 8	Sep. _____ : 00 – _____ : 00	¥		Sep. _____	¥
Total      ¥					

JASIS 2019

# Application for the Use of Open Flames and Hazardous Substances

We hereby obey the requirements listed on the page 25 and install a larger than grade 10 fire extinguisher.

Exhibitor name: \_\_\_\_\_ Booth No. \_\_\_\_\_  
Address: \_\_\_\_\_ Phone: \_\_\_\_\_  
\_\_\_\_\_ Fax: \_\_\_\_\_  
Section \_\_\_\_\_ Name: \_\_\_\_\_

**Deadline: Submit one copy by Monday, July 1.**

**Submit to:**

**TEN Corporation**

Order by Fax: +81-3-3842-7720 or Email: jasis@teninc.co.jp

This application shall be along with the following information:

1. Your brief demonstration abstract, along with the machinery specification catalogue if hazardous substance is stored as a part of your demonstration device.
2. Your booth layout with specification of each hazardous storage spot; including inner storage tank(s) in your demonstration device.
3. Safety measures storing each hazardous substance.

**We are applying for the use of the following hazardous substances.**

\* Indicate the types of hazardous substances and the amounts you will be using per day.

**NOTE:**

Fire inspection is required on the day before the opening of the show and an exhibitor MUST attend the inspection. The inspection time will be notified by the secretariat.

Exhibitors who withdraw their application MUST hand-in the copy of "Notification of withdrawal of dangerous goods" to the inspector at the inspection; please contact the secretariat for the form.

The inspection time may be after 17:00. If inspection is not properly completed, not only will exhibition by the exhibitor in question not be allowed, but the JASIS show itself may be subject to cancellation. Do not fail to undergo inspection.

# Application for Water, Drainage, Compressed Air and Town gas piping construction

Exhibitor name: \_\_\_\_\_ Booth No. \_\_\_\_\_  
 Address: \_\_\_\_\_ Phone: \_\_\_\_\_  
 \_\_\_\_\_ Fax: \_\_\_\_\_  
 Section \_\_\_\_\_ Name: \_\_\_\_\_

Billing address if different from above:

Company name:	Phone:
Address:	Fax:
Section:	Name:

**Deadline: Monday, July 1.**

**Submit to: TEN Corporation**

Via Fax: +81-3-3842-7720 or Email: jasis@teninc.co.jp

Contractor for Primary Supply	Yamazaki Kogyosho Co., Ltd. (Contact: Mr. Katsuya / Mr. Hattori)
	Email: Katsuya@kk-yama.com 4-23-17 Honcho, Nakano-ku, Tokyo, 164-0012, Japan Phone: +81-3-3383-3541 Fax: +81-3-3380-1298
Contractor for Piping within Booth	Company name: _____ Contact: _____
	Address: _____ TEL: _____
	Fax: _____

\* Gas work shall be conducted by Yamazaki Kogyosyo Co., Ltd. Both for primary supply and in-booth piping.  
 \* Consult Yamazaki Kogyosho when you do not have designated contractor.

<input type="checkbox"/> Water and Drainage	Connection	<input type="checkbox"/> Instruments	<input type="checkbox"/> Sink Tap	<input type="checkbox"/> Others
	Pipe diameter	<input type="checkbox"/> 13 mmø	<input type="checkbox"/> 20 mmø	<input type="checkbox"/> 25 mmø <input type="checkbox"/> Others
	Drain diameter	<input type="checkbox"/> 40 mmø	<input type="checkbox"/> 50 mmø	<input type="checkbox"/> <input type="checkbox"/>
<input type="checkbox"/> Compressed Air	Flow	_____ L/min		
	Pipe diameter	<input type="checkbox"/> 13 mm	<input type="checkbox"/> 20 mm	<input type="checkbox"/> 25 mm <input type="checkbox"/> Others
<input type="checkbox"/> Town Gas	Pipe diameter	<input type="checkbox"/> 13 A	<input type="checkbox"/> 15 A	<input type="checkbox"/> 20 A <input type="checkbox"/> Others

\* To use town gas at your booth, the "Application for the Use of Open Flames and Hazardous Substances" (form 4) shall be submitted and the permit is required.  
 \* Please submit the brochure copy of the instruments using town gas to register the gas demands at your booth.

comment	
---------	--

Supply Position at the Booth (booth drawings would be helpful)

JASIS 2019

# Application for Change of Address or Number of Tags for Exhibitors

---

Up to 10 tags per booth will be supplied to each exhibitor.

The tags will be sent to the contact person of your exhibition in the beginning of August.

If you need more tags, or to change the address to receive them, please fill out the following.

## ... Change of Address to Receive tags ...

Change    Yes / No

(Only in the case of Yes, please fill out the following.)

Exhibitor name:

---

Address:

---

Section:

Name:

---

Phone:

Fax:

---

## ... Change of number of tags ...

Change    Yes / No

(Only in the case of Yes, please fill out the following.)

<b>New number of exhibitor tags:</b>
--------------------------------------

<b>Tags</b>
-------------

**Deadline: Submit one copy by Friday, July 5.**

**Submit to: JASIS Organizing Committee**

**Att. Japan Analytical Instruments Manufacturers' Association**

**Via email: [webmaster@jaima.or.jp](mailto:webmaster@jaima.or.jp)**

JASIS 2019

# Confirmation Request for Products Needing Application for Industrial Property Right

---

\* Please note that the submission of this document does not complete the application for the Exhibit Certificate. The Exhibit Certificate shall be issued to you only when you request your Exhibit Certificate within seven days after the show.

For more details, please contact the Secretariat.

Exhibitor name: \_\_\_\_\_

Address: \_\_\_\_\_

Please inform the Secretariat of your choices for date and time for the examination of your products, between September 4 (Wed.) and September 6 (Fri.).

(Please specify your three alternatives, when the person in charge of your exhibits can join the confirmation from the Secretariat. The confirmation is usually completed in a few minutes.)

First choice:      Date: September \_\_\_\_\_ ,      Time: \_\_\_\_\_

Second choice:    Date: September \_\_\_\_\_ ,      Time: \_\_\_\_\_

Third choice:     Date: September \_\_\_\_\_ ,      Time: \_\_\_\_\_

**Deadline: Submit one copy by Friday, July 26.**

**Submit to: JASIS Organizing Committee**

**Att. Japan Analytical Instruments Manufacturers' Association**

Via email: [webmaster@jaima.or.jp](mailto:webmaster@jaima.or.jp)





JASIS 2019

# Application for Temporary Phone and Internet

Exhibitor name: \_\_\_\_\_ Booth No. \_\_\_\_\_  
 Address: \_\_\_\_\_ Phone: \_\_\_\_\_  
 \_\_\_\_\_ Fax: \_\_\_\_\_  
 Section \_\_\_\_\_ Name: \_\_\_\_\_

Billing address if different from above:

Company name:	Phone:
Address:	Fax:
Section:	Name:

**Deadline: Submit one copy by Friday, July 26.**

**Submit to: Kissei Comtec Co., Ltd.**

Contact: Toda (Mr.), Akiyama (Mr.)

Phone: +81-3-6709-2440 Fax: +81-3-5979-6335

e-mail: jasis@network.kcrent.jp

**We are applying for the installation of the following temporary  
phone and Internet**

**An invoice will be issued after receipt of application.**

**Please complete remittance by August 16.**

Phone: \_\_\_\_\_ line(s)  
(¥17,500)

Phone equipment: Exhibitor's equipment / Lease

Fax equipment: Exhibitor's equipment / Lease

DSU: Exhibitor's equipment / Lease

Optical Fiber: \_\_\_\_\_ line(s)  
(¥86,400)

Indicate the location of the equipment in your booth.

**For your own Wi-Fi set-up and its fees, please inquire to Mr. Toda / Mr. Akiyama**

JASIS 2019

# Application for the Use of Drayage Machinery<sub>(chargable)</sub>

Exhibitor name: \_\_\_\_\_ Booth No. \_\_\_\_\_  
 Address: \_\_\_\_\_ Phone: \_\_\_\_\_  
 \_\_\_\_\_ Fax: \_\_\_\_\_  
 Section \_\_\_\_\_ Name: \_\_\_\_\_

Billing address if different from above:

Company name:	Phone:
Address:	Fax:
Section:	Name:

**Deadline: Friday, July 26.**

**Submit to: Cap Co., Ltd.**

4-25-18 Higashi-Shinkoiwa, Katsushika-ku, Tokyo, 124-0023  
 Phone: +81-3-3695-0623 Fax: +81-3-3695-3088  
 Email: ookawara@cap1236.co.jp

**We are applying to use the following drayage machinery:**

(Circle all applicable items on lines marked with "**".)			
Number of items:	* Packing style:	Unpacked	Packed
Weight: Maximum weight per item:	( ) kg / Total weight:	( ) kg	
Volume: Maximum volume per item:	Length ( ) × width ( ) × height ( ) m		
* Mode of transport:	1 Automobile	2 Container	3 Mixed parcels 4 Others
* Entity responsible for transport:	1 Cap Co., Ltd.	2 Exhibitor	3 Transport company appointed by the exhibitor
* Hall workers:	1 Cap Co., Ltd.	2 Exhibitor	3 Company appointed by the exhibitor
* Insurance:	1 Comprehensive exhibit insurance	2 Transportation insurance	3 Others
Insured amount: ¥			If you require insurance, please call Cap Co., Ltd.
* Type of vehicle:	4-ton truck: ( ) truck(s)	10-ton truck: ( ) trucks(s)	
Fork lift or tow truck			
Remarks:			

# Application for dispatch of translators and reception staff

Exhibitor name: \_\_\_\_\_ Booth No. \_\_\_\_\_

Address: \_\_\_\_\_ Phone: \_\_\_\_\_

\_\_\_\_\_ Fax: \_\_\_\_\_

Section: \_\_\_\_\_ Name: \_\_\_\_\_

**Deadline: Submit one copy by Friday, July 26.**

**Submit to: GR Congress**

**Attn: Ms. Abe** (staff@grex-event.com)

TEL : +81-3-6427-8346 FAX : +81-3-6427-8349

**Use the following form to request for dispatch of interpreters and reception staff.**

1. Bilingual staff (English)	¥ 23,000	•Returnees from abroad, now students Achieve communication with international visitors to exhibitor booths, performance of miscellaneous duties. Contracts, business negotiations, and press are not possible.	From Sep.____ to Sep.____
2. Middle class interpretation (English)	¥ 32,000	•Interpreters who are either currently studying interpretation or have lived abroad, and have office experience Besides achieving communication, they will be capable of some business negotiations. However, contracts and press are not possible.	From Sep.____ to Sep.____
3. General interpretation (English)	¥ 46,000	•Professional interpreters Recommended for business negotiations that may progress to contract agreements.	From Sep.____ to Sep.____
4. Korean/Chinese speaking staff	¥ 26,000	•Students Achieve communication with visitors to exhibitor booths from Korea and China, performance of miscellaneous duties. Contracts, business negotiations, and press are not possible.	From Sep.____ to Sep.____
5. General interpretation (French, German, Chinese, Korean, Cantonese, Spanish, Italian)	¥ 53,000	•Professional interpreters Recommended for business negotiations that may progress to contract agreements.	From Sep.____ to Sep.____
6. Reception (Japanese only)	¥ 21,000	•Profiles will be sent in advance. Note: Quotes for rental uniforms, etc. will be submitted separately.	From Sep.____ to Sep.____
7. Narrator (Japanese only)	¥ 40,000~	•Charge varies somewhat with skill and appearance. Note: Quotes for rental uniforms, etc. will be submitted separately.	From Sep.____ to Sep.____

Note: Charges quoted above are per person per 1 day and includes commuting to the venue and lunch. 8% consumption tax will apply.

## Application precautions

- ① Fill in the application and send by FAX. GR congress will provide an invoice. (International exhibitors may also pay in cash at the organizers secretariat in the venue on the second day of the show.
- ② Narrator charges may vary according to script contents and memorization.
- ③ Working hours are as a rule from 30 minutes prior to show opening to show closing.
- ④ Cancellation fee for interpretation/reception: 7 to 4 days prior to first day of show: 60% of total charge  
3 days prior to first day of show to first day: 90% of total charge  
Cancellation fee for a narrator: 2 weeks prior to first day of show to first day: 90% of total charge
- ⑤ As a rule, you need to apply by the application deadline. For applications after the deadline, 30% will be added to the above indicated charges.
- ⑥ When applying for interpreter services, please provide with the application your company's brochure and other materials that will serve as reference information for the interpreter.
- ⑦ If staff for distributing pamphlets, samples, etc., or staff for distributing and collecting questionnaires is needed, a quote will be provided separately.
- ⑧ GR Congress will contact you within 3 days of receiving this application. If you are not contacted, please telephone the contact person.

JASIS 2019

# Visa Application

---

As for supporting documents to submit to the Japanese Embassy for a visa, please submit this application form to JASIS Organizing Committee. JASIS office will contact to the registered contact person for visa applicant's information required by the Ministry of Foreign Affairs of Japan.

Exhibitor name: \_\_\_\_\_ Booth No. \_\_\_\_\_  
Address: \_\_\_\_\_ Phone: \_\_\_\_\_  
\_\_\_\_\_ E-mail: \_\_\_\_\_  
Section: \_\_\_\_\_ Name: \_\_\_\_\_

Number of the person who need VISA

Male	
Female	

**Deadline: Submit one copy by Friday, June 21.**

**Submit to: JASIS Organizing Committee**

**Att. Japan Analytical Instruments Manufacturers' Association**

Via email: [webmaster@jaima.or.jp](mailto:webmaster@jaima.or.jp)

## ■ List of Contact Addresses of the Show Office and Organizer Designated Contractors

<b>JASIS 2019 Secretariat Office</b>	<b>Att. Japan Analytical Instruments Manufacturers' Association</b> 1-12-3 Kanda-Nishiki-cho, Chiyoda-ku, Tokyo, 101-0054 Japan Phone: +81-3-3292-0642 Fax: +81-3-3292-7157 The Secretariat Office will be opened at the North Room in Exhibition Hall 6 from September 2 through September 6.	Email: webmaster@ jaima.or.jp  Contact Person: Mr. Komori
<b>Basic booth decoration,</b>	<b>TEN Corporation</b> 1-5-9 Kotobuki, Taitou-ku, Tokyo, 111-0042 Japan Fax: +81-3-3842-7720	Email: jasis@teninc.co.jp
<b>Power mains installation work</b>	<b>Iida Electrical Works Co., Ltd.</b> 1-8-21 Shinkiba, Koto-ku, Tokyo, 135-8071 Phone: +81-3-3521-3522 Fax: +81-3-3521-3524	Email: jasis@iidae.co.jp  Contact Person: Mr. Nakamura
<b>Temporary Phone and ADSL / Optical Connection</b>	<b>Kissei Comtec Co., Ltd.</b> 3-32-1 Minami Ootsuka, Toshima-ku, Tokyo 170-0005 Japan Phone: +81-3-6709-2440 Fax: +81-3-5979-6335	Email: jasis@network. kcrent.jp  Contact Person: Mr.Toda / Mr. Akiyama
<b>Water, Drainage, Compressed air and Town gas.</b>	<b>Yamazaki Kogyosho Co., Ltd.</b> 4-23-17 Honcho, Nakano-ku, Tokyo, 164-0012, Japan Phone: +81-3-3383-3541 Fax: +81-3-3380-1298	Email: katsuya@ kk-yama.com  Contact Person: Mr. Katsuya / Mr. Hattori
<b>Drayage</b>	<b>Cap Co., Ltd.</b> 4-25-18 Higashi-Shinkoiwa, Katsushika-ku, Tokyo, 124-0023, Japan Phone: +81-3-3695-0623 Fax: +81-3-3695-3088	Email: ookawara@ cap1236.co.jp  Contact Person: Ohkawara
<b>Foreign goods</b>	<b>ISHIKAWA-GUMI, LTD.</b> 4-14-2 Higashi-Oi, Shinagawa-ku, Tokyo, 140-0011, Japan Phone: +81-3-3474-8102 Fax: +81-3-5460-9841	Email: m_hasegawa@ ishikawa-gumi.co.jp  Contact Person: Ms. Hasegawa
<b>Security service</b>	<b>TEXS Corporation</b> Sun Youth Bl. 3rd floor, 5-40-9 Higashi-Ikebukuro, Toshima-ku, Tokyo, 170-0013, Japan Phone: +81-3-3590-6446 Fax: +81-3-3590-4001	Email: ikegami@ texas.co.jp Contact Person: Ikegami
<b>Dispatch of interpreters and reception staff</b>	<b>GR Congress Co., Ltd.</b> Phone: +81-3-6427-8346 Fax: +81-3-6427-8349	Contact Person: Ms. Abe  Email: staff@ grex-event.com
<b>Life Science Innovation Zone Secretariat representative office</b>	<b>A &amp; E PLANNING CO., LTD.</b> Hitotsubashi Bekkan 4F, 2-4-4, Hitotsubashi, Chiyoda-ku, Tokyo 101-0003 Japan Phone: +81-3-3230-2744 Fax: +81-3-3230-2479	Contact person: Orito, Ooki and Tanaka Email: jasis-lsz@ aepaln.co.jp
<b>Exhibition venue</b>	<b>Makuhari Messe, Inc.</b> Nakase 2-1, Mihama-ku, Chiba City, Chiba, 261-8550 Japan Phone: +81-43-296-0602 Fax: +81-43-296-0529	Contact Person: Murakami

**See you in November 2020**



**November 11<sup>th</sup>(Wed.) to 13<sup>th</sup>(Fri.), 2020**

**International Exhibition Halls,**

**Makuhari Messe**

JASIS Office

Japan Analytical Instruments Manufacturers' Association

1-12-3 Kanda Nishiki-cho, Chiyoda-ku, Tokyo, 101-0054 Japan

TEL:+81-3292-0642 FAX:+81-3292-7157

E-mail: [webmaster@jaima.or.jp](mailto:webmaster@jaima.or.jp) URL: <https://www.jasis.jp/en/>